



1N5408G

DIODE

GLASS PASSIVATED SILICON RECTIFIER

DESCRIPTION

The UTC **1N5408G** is a glass passivated silicon rectifier, it uses UTC's advanced technology to provide customers with high forward surge current and low reverse leakage, etc.

FEATURES

- * Low reverse leakage
- * High forward surge current capability

SYMBOL

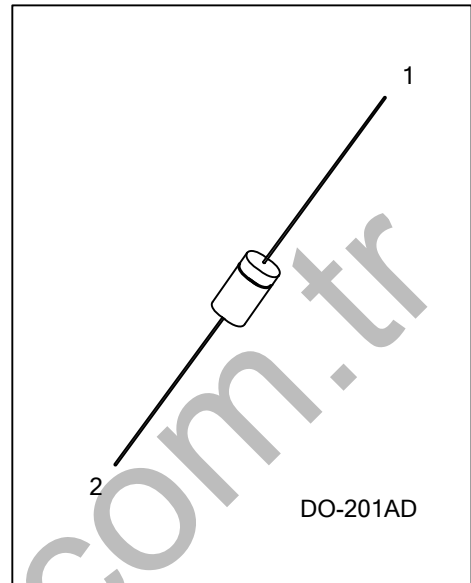
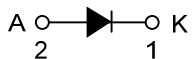

ORDERING INFORMATION

Ordering Number		Package	Pin Assignment		Packing
Lead Free	Halogen Free		1	2	
1N5408GL-Z21D-R	1N5408GP-Z21D-R	DO-201AD	K	A	Tape Reel

Note: Pin Assignment: A: Anode K: Cathode

<p>1N5408GL-Z21D-R</p> <p>(1) Packing Type (2) Package Type (3) Lead Free</p>	<p>(1) R: Tape Reel (2) Z21D: DO-201AD (3) L: Lead Free, P: Halogen Free</p>
---	--

MARKING

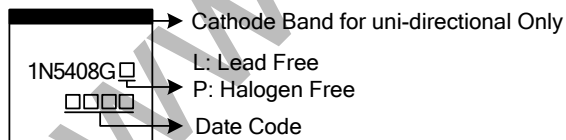

■ ABSOLUTE MAXIMUM RATINGS

Ratings at 25°C ambient temperature unless otherwise specified.

Single phase half-wave 60Hz, resistive or inductive load, for capacitive load current derate by 20%.

PARAMETER	SYMBOL	RATINGS	UNIT
Working Peak Reverse Voltage	V_{RWM}	1000	V
Repetitive Peak Reverse Voltage	V_{RRM}	1000	V
Maximum RMS Reverse Voltage	V_{RMS}	700	V
DC Blocking Voltage	V_R	1000	V
Average Rectified Output Current ($T_A=105^\circ\text{C}$)	I_O	3.0	A
Peak Forward Surge Current 8.3ms Single Half Sine-Wave Superimposed on Rated Load	I_{FSM}	200	A
Junction Temperature	T_J	-55~+150	°C
Storage Temperature	T_{STG}	-55~+150	°C

Note: Absolute maximum ratings are those values beyond which the device could be permanently damaged.

Absolute maximum ratings are stress ratings only and functional device operation is not implied.

■ THERMAL DATA

PARAMETER	SYMBOL	RATINGS	UNIT
Junction to Ambient (Note 2)	θ_{JA}	20	°C/W

■ ELECTRICAL CHARACTERISTICS

Ratings at 25°C ambient temperature unless otherwise specified.

Single phase half-wave 60Hz, resistive or inductive load, for capacitive load current derate by 20%.

PARAMETER	SYMBOL	TEST CONDITIONS	MIN	TYP	MAX	UNIT
Instantaneous Forward Voltage	V_F	$I_F=3.0\text{A}$			1.2	V
DC Reverse Current at Rated DC Blocking Voltage	I_R	$T_A=25^\circ\text{C}$			5.0	μA
		$T_A=100^\circ\text{C}$			100	μA
Junction Capacitance (Note 1)	C_J			30		pF

Notes: 1. Measured at 1MHz and applied reverse voltage of 4.0V D.C.

2. Thermal resistance from junction to ambient at 0.375" (9.5mm) lead length, P.C.B. mounted

TYPICAL CHARACTERISTICS

Forward Current Derating Curve

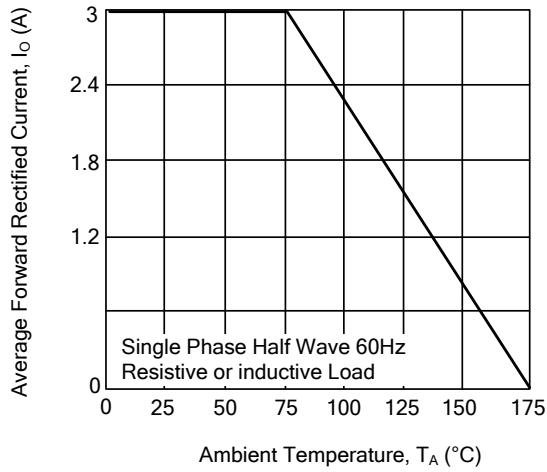

Maximum Non-repetitive Peak Forward Surge Current

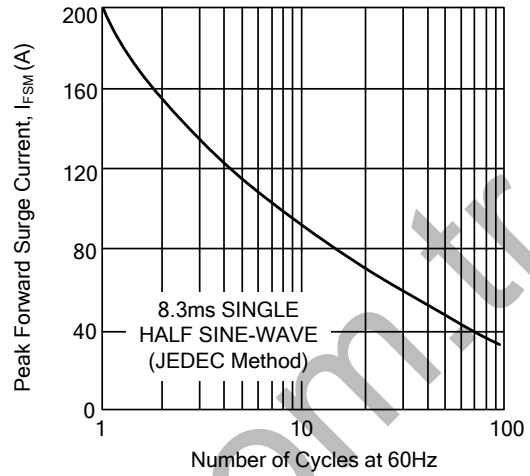

Typical Instantaneous Forward Characteristics

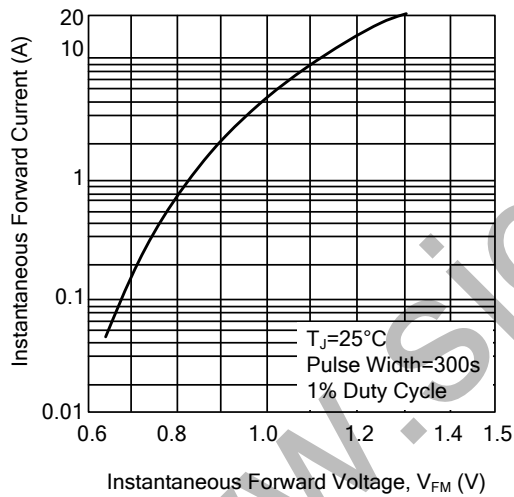

Typical Reverse Characteristics

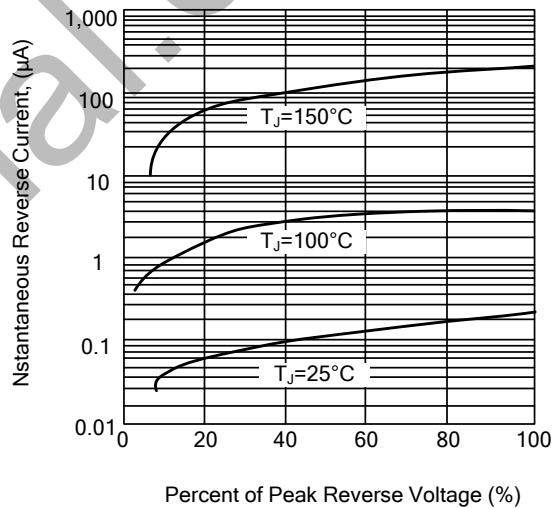

Typical Junction Capacitance

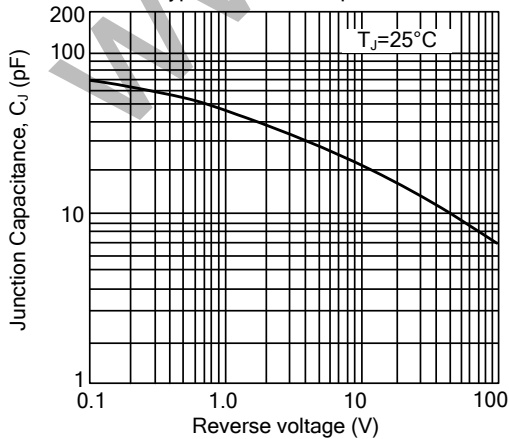

Typical Transient Thermal Impedance

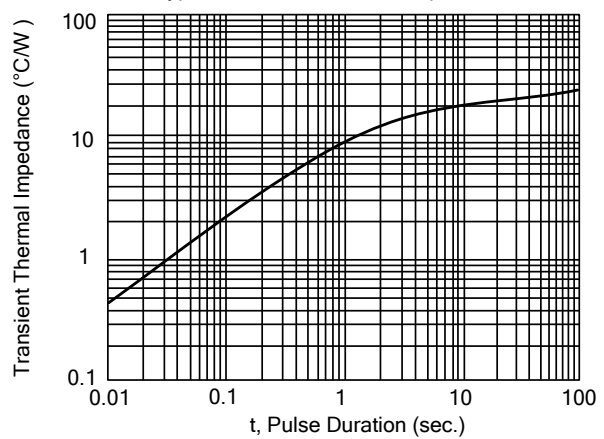

UTC assumes no responsibility for equipment failures that result from using products at values that exceed, even momentarily, rated values (such as maximum ratings, operating condition ranges, or other parameters) listed in products specifications of any and all UTC products described or contained herein. UTC products are not designed for use in life support appliances, devices or systems where malfunction of these products can be reasonably expected to result in personal injury. Reproduction in whole or in part is prohibited without the prior written consent of the copyright owner. The information presented in this document does not form part of any quotation or contract, is believed to be accurate and reliable and may be changed without notice.