



1N5819

DIODE

SCHOTTKY BARRIER DIODE

■ FEATURES

- * Schottky barrier chip
- * Low power loss, high efficiency.
- * Low forward voltage drop.
- * High surge current capability.
- * For use in low voltage, high frequency inverters, free wheeling diode, and polarity protection applications.

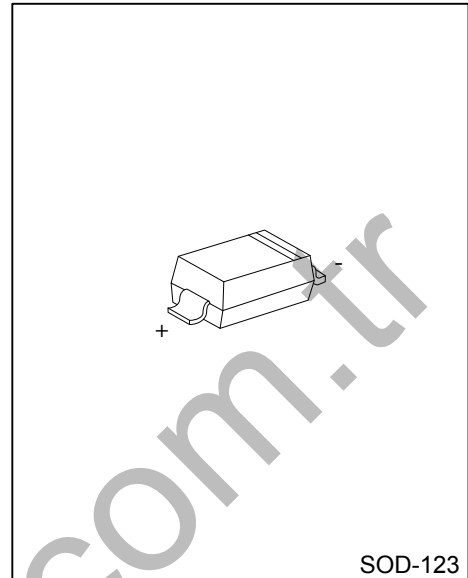

■ ORDERING INFORMATION

Ordering Number		Package	Packing
Lead Free	Halogen Free		
1N5819L-CA2-R	1N5819G-CA2-R	SOD-123	Tape Reel

<p>1N5819L-CA2-R</p>	<p>(1)Packing Type</p> <p>(2)Package Type</p> <p>(3)Lead Plating</p>	<p>(1) R: Tape Reel</p> <p>(2) CA2: SOD-123</p> <p>(3) G: Halogen Free, L: Lead Free</p>
----------------------	--	--

■ MARKING

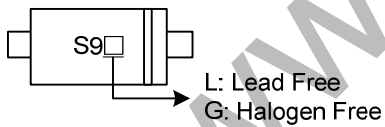

■ ABSOLUTE MAXIMUM RATINGS (Single Diode @Ta=25°C)

PARAMETER	SYMBOL	RATINGS	UNIT
Maximum Repetitive Peak Reverse Voltage	V_{RRM}	40	V
Maximum non-repetitive Peak Reverse Voltage	V_{RM}	40	V
Maximum DC Blocking Voltage	V_R	40	V
Working Peak Reverse Voltage	V_{RWM}	40	V
Maximum RMS Reverse Voltage	$V_{R(RMS)}$	28	V
Repetitive Peak Forward Current	I_{FRM}	625	mA
Non-repetitive Peak Forward Surge Current 8.3ms Single Half-Sine-Wave	I_{FSM}	25	A
Average Forward Rectified Output Current	I_{OUT}	1	A
Power Dissipation	P_D	250	mW
Storage Temperature	T_{STG}	-65~+150	°C

Note: Absolute maximum ratings are those values beyond which the device could be permanently damaged.
Absolute maximum ratings are stress ratings only and functional device operation is not implied.

■ THERMAL DATA

PARAMETER	SYMBOL	RATINGS	UNIT
Junction to Ambient	θ_{JA}	500	°C/W

■ ELECTRICAL CHARACTERISTICS (Ta=25°C, unless otherwise specified)

PARAMETER	SYMBOL	TEST CONDITIONS	MIN	TYP	MAX	UNIT
Forward Voltage	V_F	$I_F=1A$			0.6	V
		$I_F=3A$			0.9	V
Reverse Breakdown Voltage	BV_R	$I_R=1mA$	40			V
Reverse Leakage Current	I_R	$V_R=40V$			1	mA
Diode Capacitance	C_D	$V_R=4V, f=1MHz$			120	pF

TYPICAL CHARACTERISTICS

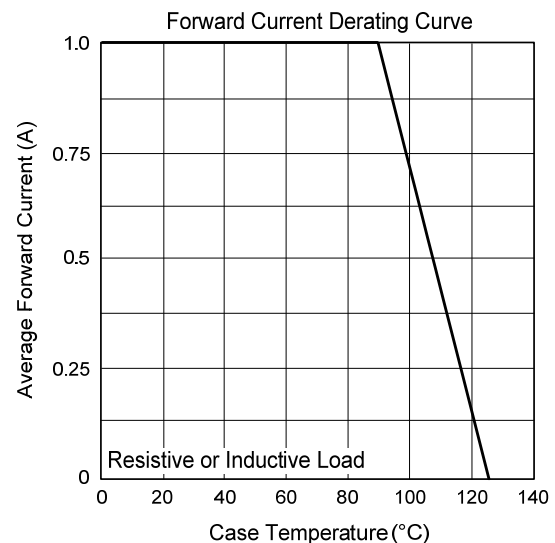
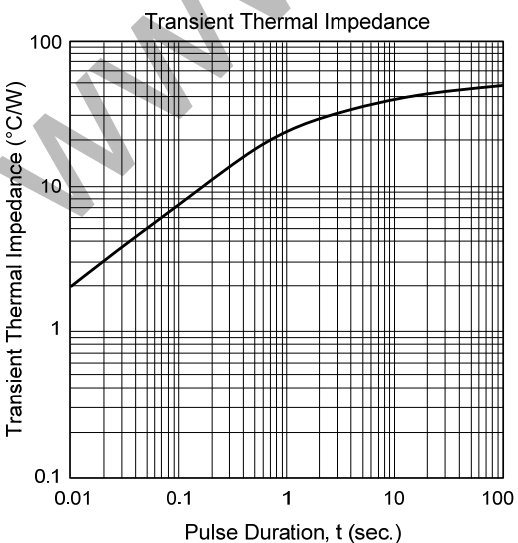
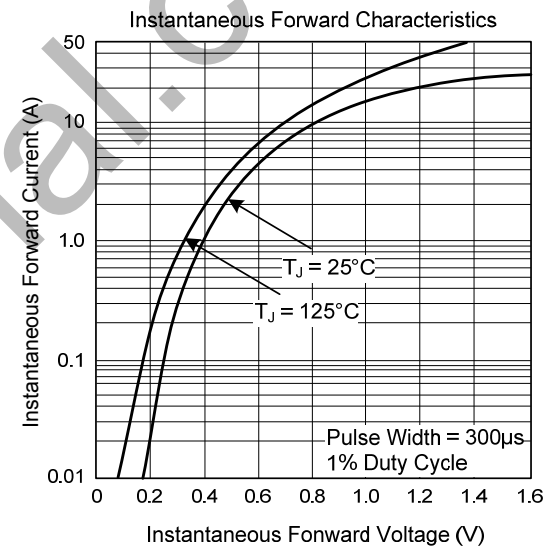
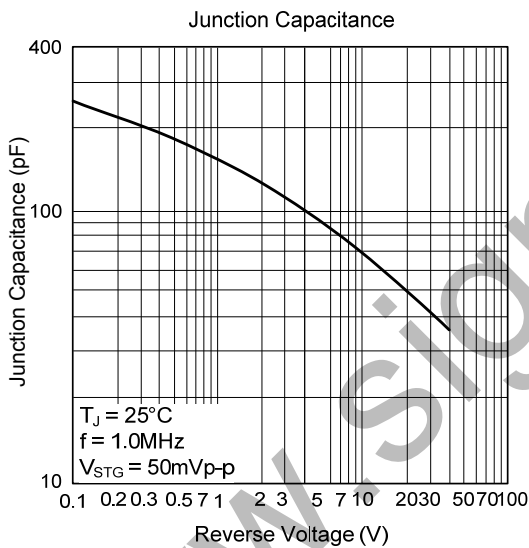
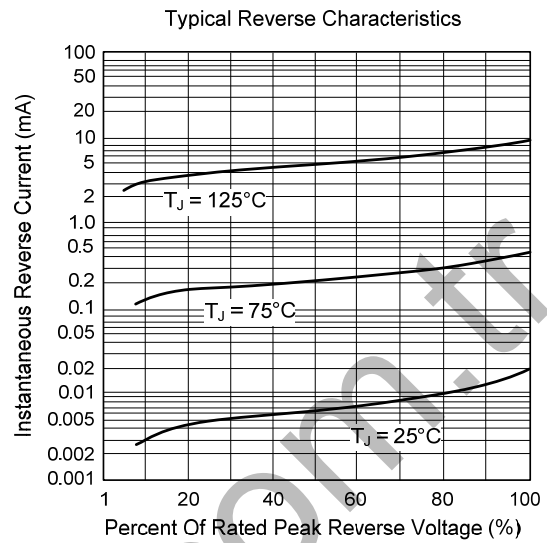
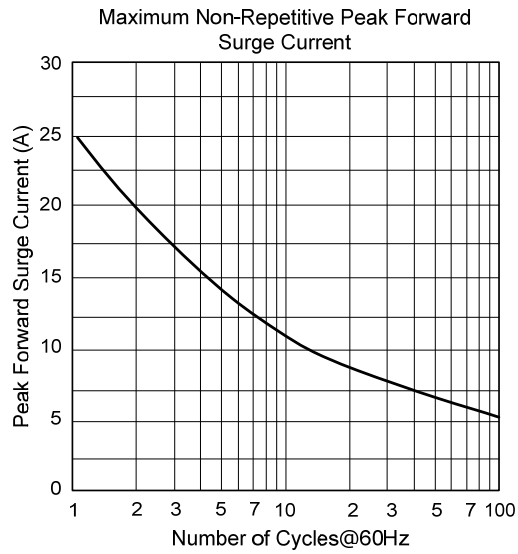

UTC assumes no responsibility for equipment failures that result from using products at values that exceed, even momentarily, rated values (such as maximum ratings, operating condition ranges, or other parameters) listed in products specifications of any and all UTC products described or contained herein. UTC products are not designed for use in life support appliances, devices or systems where malfunction of these products can be reasonably expected to result in personal injury. Reproduction in whole or in part is prohibited without the prior written consent of the copyright owner. The information presented in this document does not form part of any quotation or contract, is believed to be accurate and reliable and may be changed without notice.