

2.5mm Terminal / Housing / Wafer R/A / Straight Type

Specifications
 Current Rating: 3A AC,DC
 Voltage Rating: 500V AC,DC
 Temperature Range: -25°C to +85°C
 Contact Resistance: 20mΩ Max
 Insulation Resistance: 100MΩ Min
 Withstanding Voltage: 1500V AC/minute
 Terminal: Brass / Tin Plated
 Material: Nylon 66,UL94V-0

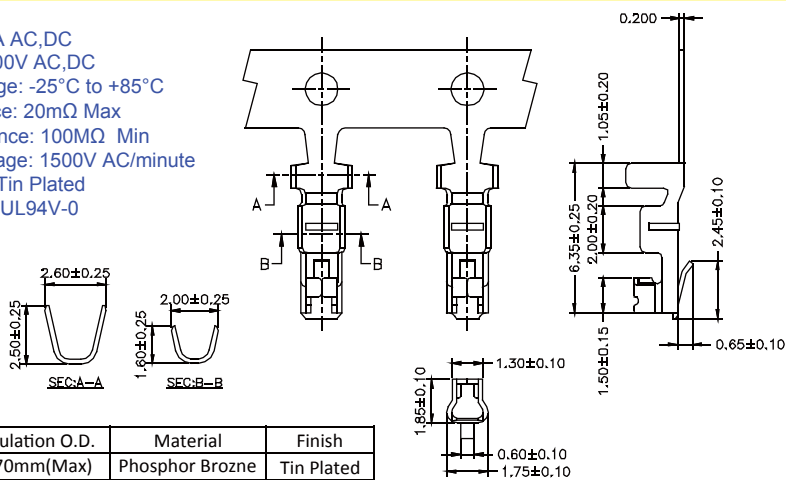

Wire Range	Insulation O.D.	Material	Finish
#22-#28	1.70mm(Max)	Phosphor Bronze	Tin Plated

Part No.:2504-T-L

No. of Contacts	Dimensions	
	A	B
2	2.50	5.50
3	5.00	8.00
4	7.50	10.50
5	10.00	13.00
6	12.50	15.50
7	15.00	18.00
8	17.50	20.50
9	20.00	23.00
10	22.50	25.50
11	25.00	28.00
12	27.50	30.50
13	30.00	33.00
14	32.50	35.50
15	35.00	38.00

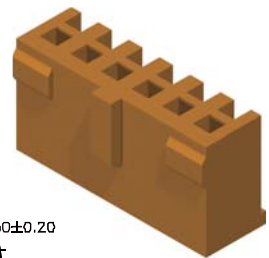
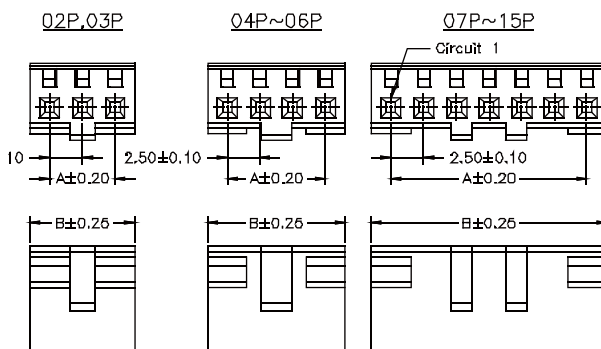

Part No.:2504H-XXR-L

No. of Contacts	Dimensions	
	A	B
2	2.50	5.00
3	5.00	7.50
4	7.50	10.00
5	10.00	12.50
6	12.50	15.00
7	15.00	17.50
8	17.50	20.00
9	20.00	22.50
10	22.50	25.00
11	25.00	27.50
12	27.50	30.00
13	30.00	32.50
14	32.50	35.00
15	35.00	37.50

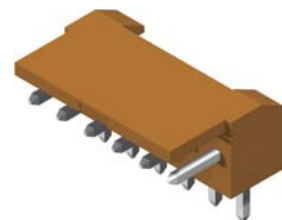
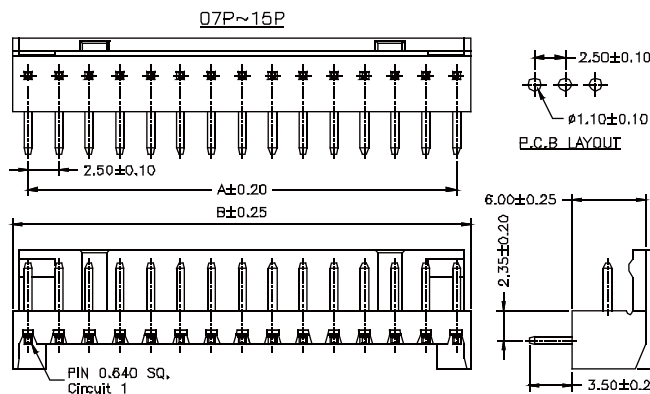

Part No.:2504R-XXTR-L

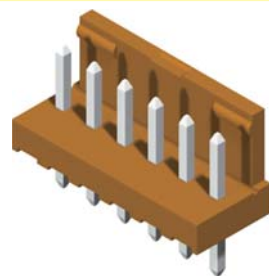
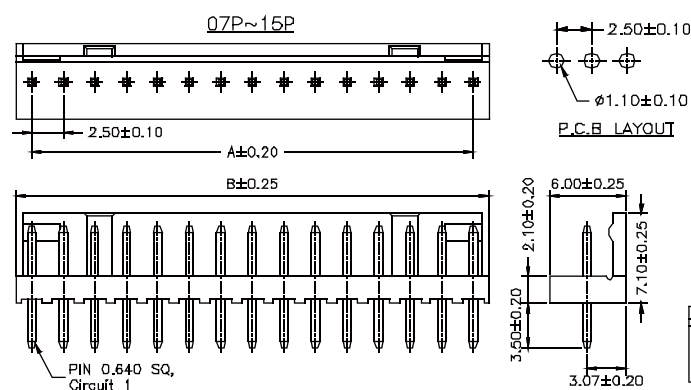

Part No.:2504S-XXTR-L