

Box Header 2.54mm Press Fit Type

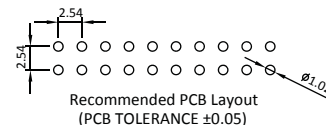

Part No.:BH1FS-XX-L

Box Header 2.54mm H=13.6mm Right Angle / Straight Type

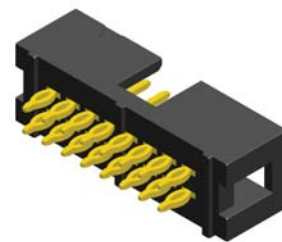
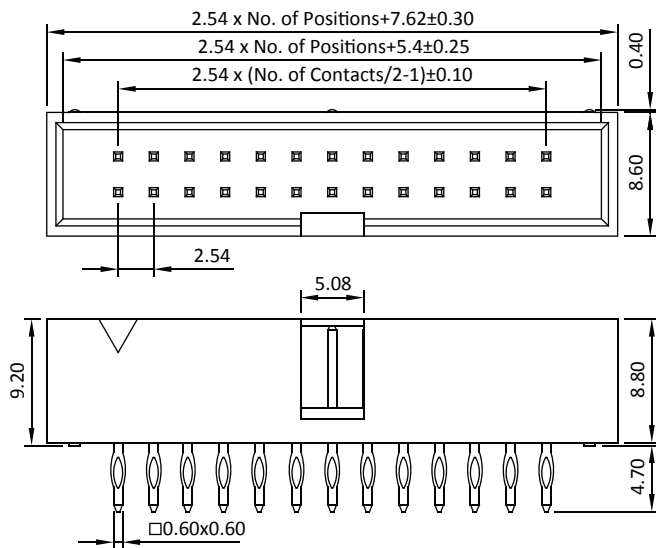
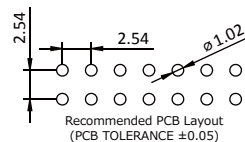
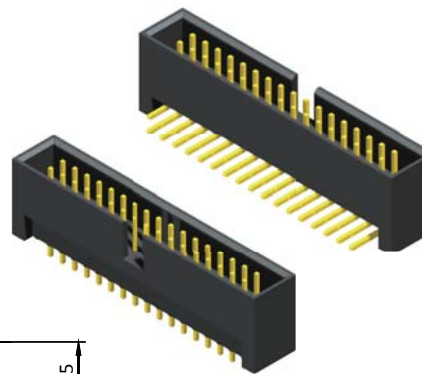
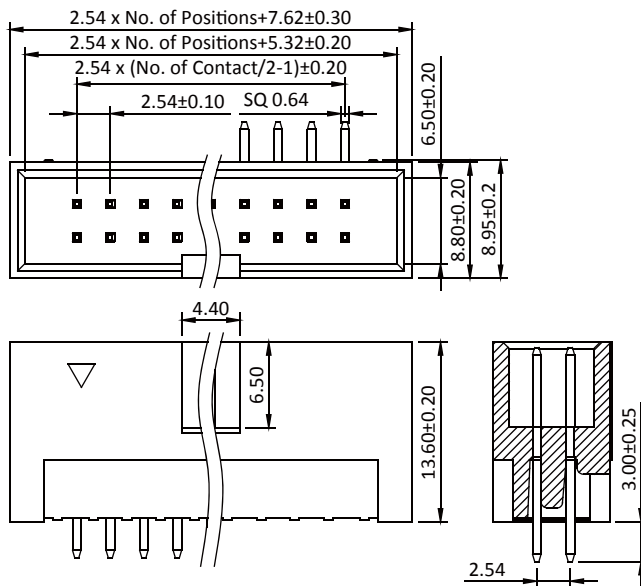

Part No.:BH1AR/S-XX-L/U

Box Header 2.54mm IDC Type

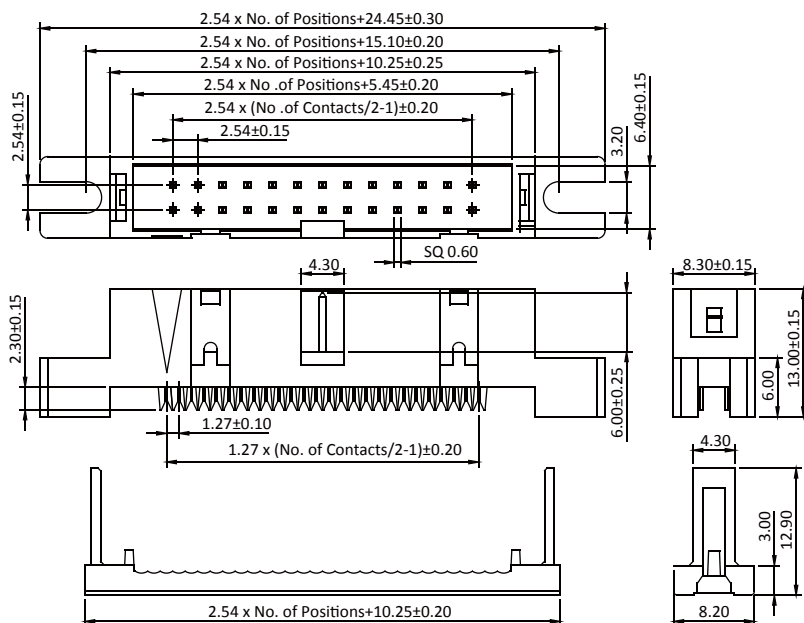

Part No.:BH1I-XX-L