

HT-01S

**Humidity & Temperature
Sensor Module**

User's Manual

MiCo SnP

History

Date	Description
2013-03-30	Initial Release. (Manual Integration)
2013-08-06	Addition output voltage table
2014-02-27	Interface circuit(Fig.10) and I2C address(Fig.12)

1. Features

- On-Chip humidity & temperature sensors
- Fully calibrated, various output (I²C, Voltage)
- Excellent long-term stability
- Low power consumption
- Serial interface control (I²C)
- Small size

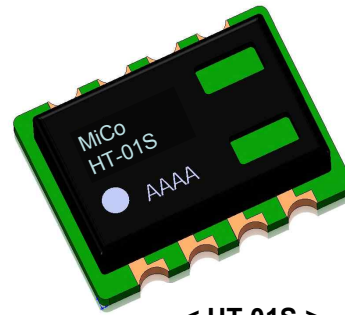

< HT-01S >

HT-01S Product Summary

The HT-01S is a humidity & temperature sensor. The device includes a relative capacitive humidity sensor elements and a band-gap temperature sensor with capacitive-to-voltage converter (C-V Converter). This results in superior signal quality, a fast response time and insensitivity to external disturbances at a very competitive price. Each HT-01S is individually calibrated in a precision chamber. The calibration coefficients are programmed into the memory. These coefficients are used internally during measurements to calibrate the signals from the sensors. The serial interface and internal voltage regulation allows easy and fast system integration. Its small size and low power consumption makes it the ultimate choice for even the most demanding applications. The device is supplied in surface mountable devices. Customer specific packaging options may be available on request.

<u>HT</u>	:	<u>01</u>	<u>S</u>
①		②	③

①	Humidity-Temperature
②	Product Number
③	SMD Type

Application

- HVAC
- Automotive
- Consumer Goods
- Weather Stations
- Humidifiers
- Test & Measurement
- Data Logging
- Automation
- White Goods
- Medical

2. Specification

Table.1 Specification for humidity sensor

Parameter	Condition	min	typ	max	Units
Resolution			14		bit
Operating Range		0		100	%RH
Accuracy	Typical		±2.5		%RH
	Maximal	See figure 1,3			
Hysteresis			<±1.5		%RH
Response time				10	sec

Table.2 Specification for temperature sensor

Parameter	Condition	min	typ	max	Units
Resolution			14		Bit
Operating Range		-40		120	°C
Accuracy	Typical		±0.5		°C
	Maximal	See figure 2			
Response time		15		25	sec

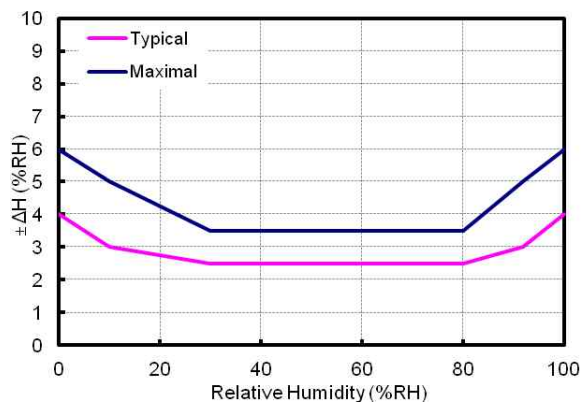

Fig.1 Humidity-accuracy at 25°C

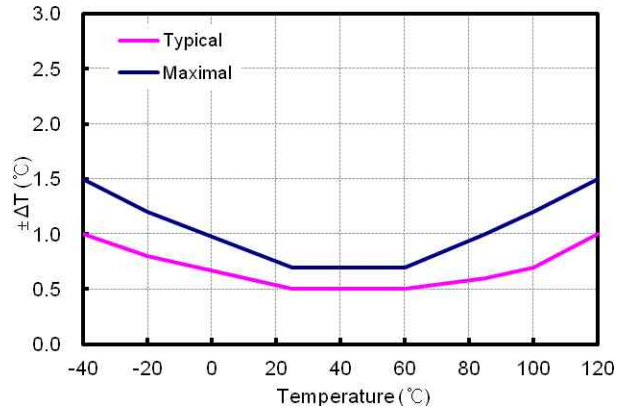

Fig.2 Temperature-accuracy.

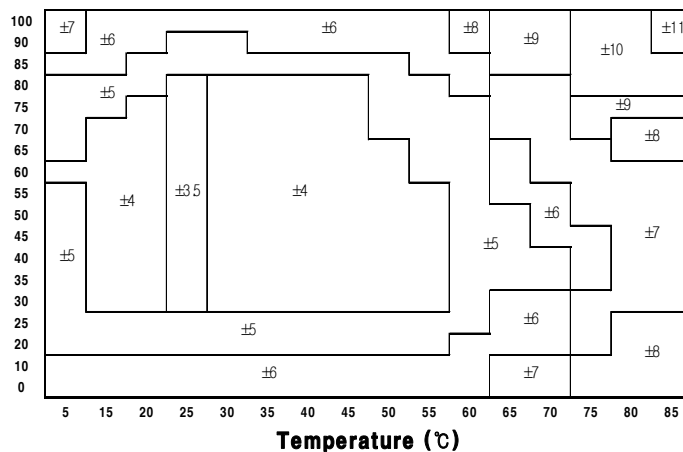

Fig.3 Maximal tolerance of relative humidity at different temperature

3. Reliability of Humidity Sensor

1) Normal operating Range

The sensor works stable within recommended normal range(see Figure. 3). Long term exposures to conditions outside normal range, especially at humidity >80%RH, may temporarily offset the RH signal. After return to normal range it will slowly return towards calibration state by itself.

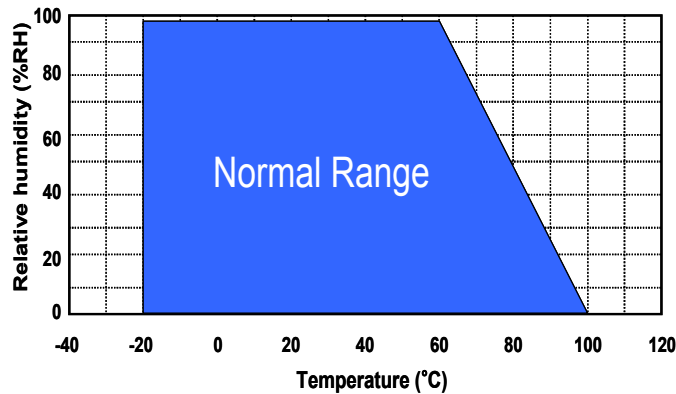

Fig.4 Normal operating range.

2) Hysteresis of Characteristics

The graph shows the hysteresis curve of HT-01S sensor. Considering the relative humidity of the sensor, the hysteresis formula is give by

$$\text{Hysteresis Value} = H(10\%RH \rightarrow 90\%RH) - H(90\%RH \rightarrow 10\%RH)$$

The hysteresis variety of samples indicate $\Delta H < \pm 1.5\%RH$ at each humidity point. This result shows that the sensor satisfies our specification. The meter is set to measure humidity value at $V_{DD} = 5V$. For the precise measurement, we used the hygrometer and compared with the humidity of temperature-humidity chamber.

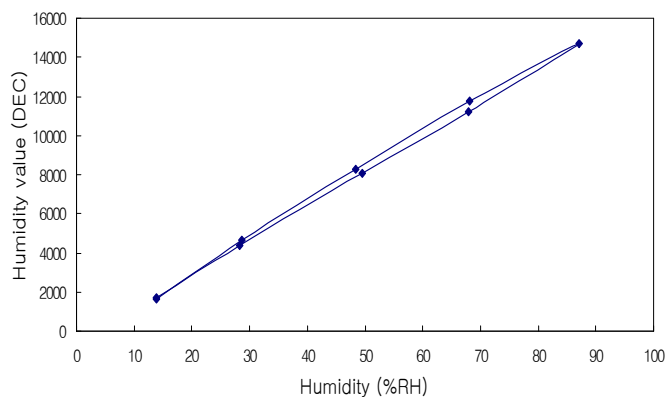
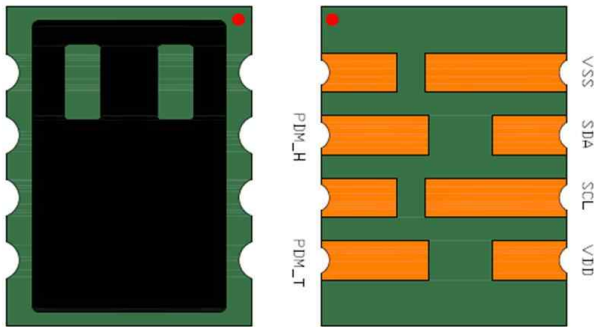

Fig.5 Hysteresis of Humidity Sensor

4. Dimension

1) HT-01S



Name	Pin Function
VSS	Ground
SDA	Serial Data
SCL	Serial Clock
VDD	DC Power

5. Soldering Instructions

The sensor has a bottom pad is plated with Ni/Pd/Au on the copper layer. These pads have to be soldered to the PCB pad for mechanical and electrical connection.

The connected PCB pad should be 0.2 mm longer than the sensor pad.

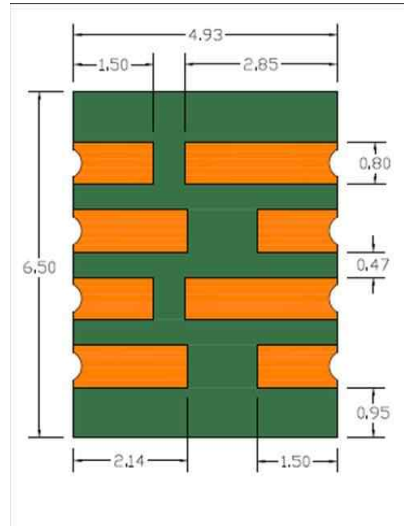
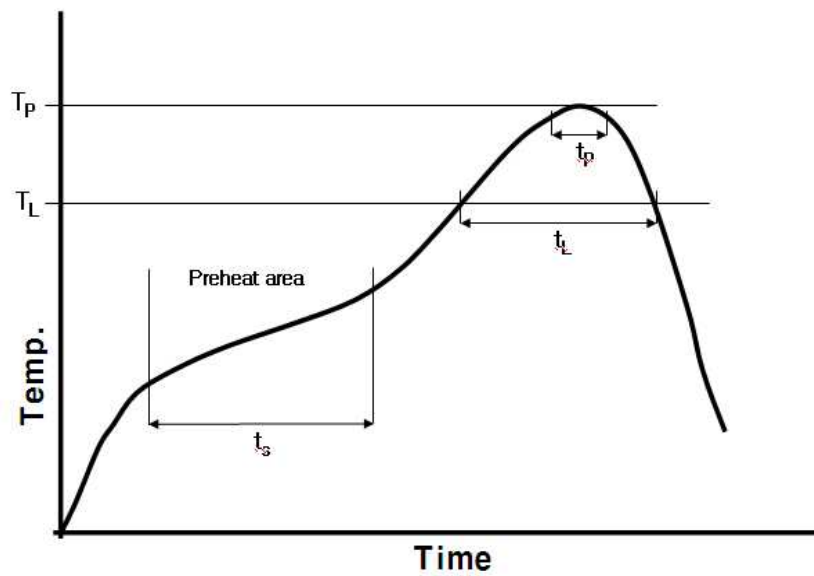

Fig.6 Recommended PCB metal pattern for HT-01S.

For soldering sensors, standard reflow soldering ovens may be used.

The sensor is treated under temperature of 260 °C with Pb-free assembly in reflow ovens. Figure 12 shows the sensor soldering profile. (After soldering, the sensor should be carried out re-hydration process.)

For manual soldering contact time must be limited to 5 seconds at up to 350 °C.



Profile Feature	Pb-free assembly
Preheat area	Max 200 °C 60~120 sec
Ramp-up rate	3 °C/sec
Liquidous temperature (T_L) Time (t_L)	217 °C 60~150sec
Peak temperature (T_P) Time (t_p)	260 °C Max 30sec
Ramp-down rate	6 °C/sec

Fig.7 The soldering profile for sensors.

6. Reconditioning Procedure

The sensor exposed to extreme conditions or chemical solvents may have offset. The following reconditioning procedure may bring back to the calibrated state of device.

- Baking : 100 °C for 8 hours
- Re-Hydration : 85°C, 85 %RH for 72 hours

7. Shipping details

HT-01S was packaged in tape and reel. Sensors are placed in the tape with the backside up.

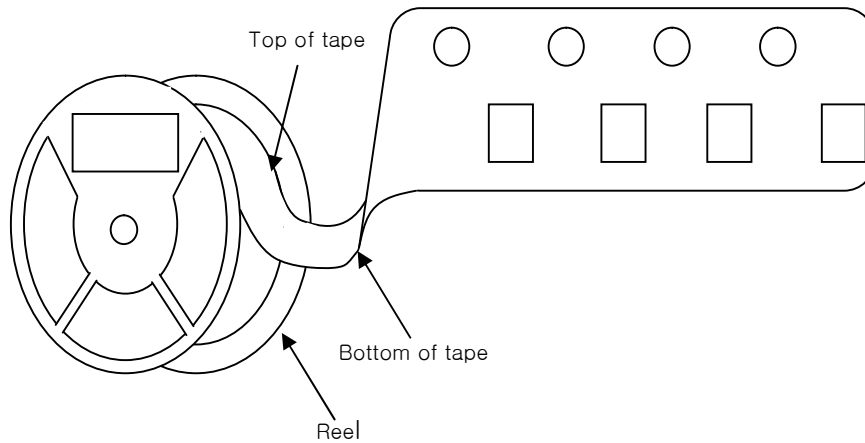

Fig.8 The tape and reel package.

8. Storage instructions

The storage instructions must be followed precisely in order to guarantee specification. Guarantees are one-year storage of the sensor package. Chemical vapors at high concentration in combination with long exposure times may offset the sensor reading.

9. Block Diagram

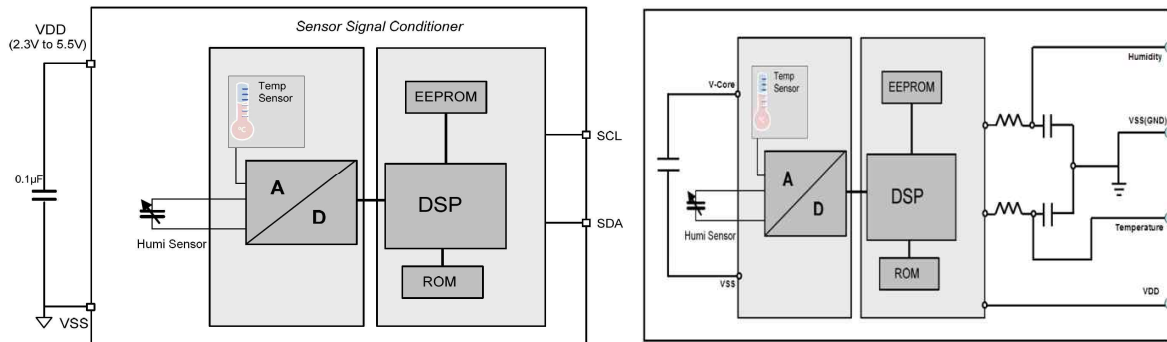

Fig.9 HT-01S Block diagram

10. Operating Condition

1) Absolute Maximum Ratings

Parameter	Symbol	Min	Typ	Max	Units
Analog Supply Voltage	V_{DD}	-0.3		6.0	V
Voltages at Analog I/O In Pin	V_{INA}	-0.3		$V_{DD}+0.3$	V
Voltages at Analog I/O Out Pin	V_{OUTA}	-0.3		$V_{DD}+0.3$	V
Storage Temperature Range	T_{STOR}	-55		150	°C

2) Operating Conditions

Parameter	Symbol	Min	Typ	Max	Units
Supply Voltage to GND	V_{SUPPLY}	2.3	5	5.5	V
Ambient Temperature Range	T_{AMP}	-40		125	°C
External Capacitance between V_{DD} pin and GND	$C_{VSUPPLY}$	100	220	470	nF
External Capacitance between V_{CORE} pin and GND	C_{VCORE}	10		110	nF
I ² C Pull-up Resistor	R_{PU}	1	2.2	10	kΩ
SDA Load Capacitance	C_{SDA}			0.2	nF
Current	Digital output	I_{sleep}	1	3	µA
	Voltage output	I_{total}	901	1253	µA

11. Circuit Interface

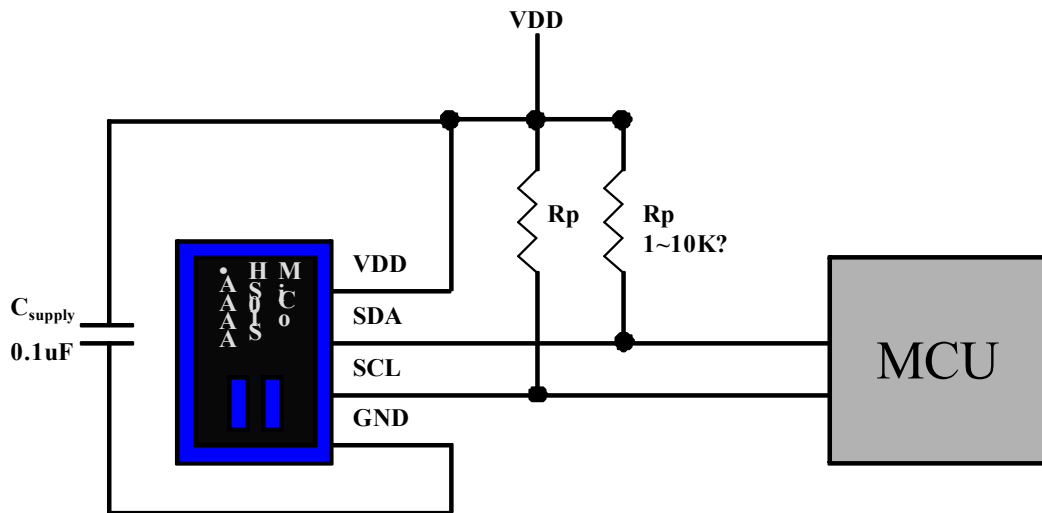

Fig.10 HT-01S I²C Interface

1) Power

The HT-01S requires a voltage supply between 2.3 and 5.5V. After power on, the device needs 10ms to reach measurement state. No commands should be sent. If you send command at that time, you cannot receive correct data from sensors.

2) Serial Clock (SCL)

The SCLK is used to synchronize the communication between a microcontroller and the HT-01S. Since the interface consists of fully static logic there is no minimum SCL frequency.

3) Serial Data (SDA)

The SDA pin is used to transfer data in and out of the device. Data changes after the falling edge and is valid on the rising edge of the serial clock SCL. During transmission the SDAT line must remain stable while SCL is high. An external pull-up resistor is required to pull the signal high.

12. I²C Interface

For integration with the micro-controller, the HT-01S has a I²C-compatible interface which supports both 100 kHz and 400 kHz bit rate. The I²C slave address is programmed by default on 28_H and can be adjusted in the entire address range of (00_H to 7F_H).

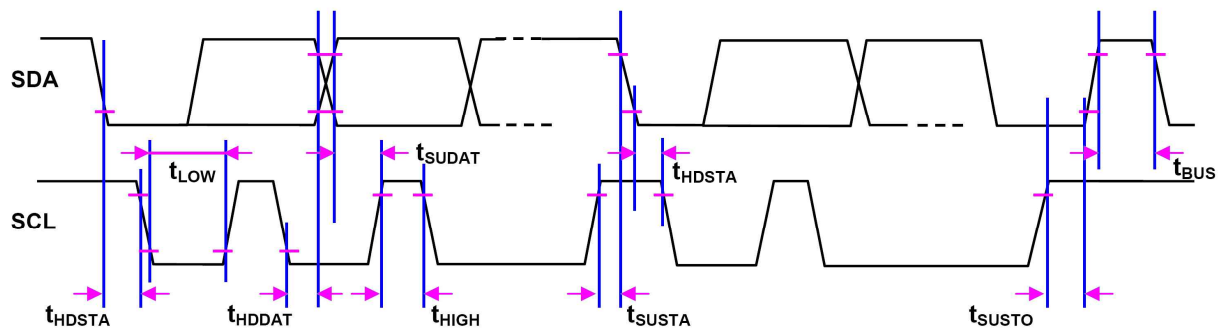

Fig.11 I²C Timing Diagram

1) I²C Parameters

Parameter	Symbol	Min	Max	Units
SCL clock frequency	f_{SCL}	100	400	kHz
Start condition hold time relative to SCL edge	t_{HDSTA}	0.1		μ S
Minimum SCL clock low width	t_{LOW}	0.6		μ S
Minimum SCL clock high width	t_{HIGH}	0.6		μ S
Start condition setup time relative to SCL edge	t_{SUSTA}	0.1		μ S
Data hold time on SDA relative to SCL edge	t_{HDDAT}	0		μ S
Data setup time on SDA relative to SCL edge	t_{SUDAT}	0.1		μ S
Stop condition setup time on SCL	t_{SUSTO}	0.1		μ S
Bus free time between stop condition and start condition	t_{BUS}	1		μ S

13. I²C commands

As detailed in below table, there are two types of commands for user operating a HT-01S. The Measurement Request (MR) is wake up command sent by the master for a new measurement cycle. The Data Fetch (DF) command is used to fetch data in I²C communication. With the start of communication the entire output packet will be loaded in a serial output register. The register will be updated after the communication is finished. The output is always scaled to 14-bits programmed resolution.

I²C command types

Type	Descriptions
Measurement Request(MR)	Start measuring cycle
Data Fetch(DF)	Used to fetch data in any digital mode

Humidity modules do not carry out internal arithmetic operation to minimize on the current consumption. A measurement process is carried out only after the command measuring request (MR) is received.

1) Measurement Requests (MR)

By a measurement request command, the HT-01S is woke up and it executes a measuring cycle. The measuring cycle begins with the temperature measurement, followed by humidity measurement, digital signal processing and finally writing the measured values into the output register.

The MR command consists of the address of the HT-01S, with which the R/W bit is transferred as 0(= write). The real signal of MR is 0x50 adding write bit(0) to address(0x28). After the humidity module is answered with ACK (= measurement started), the master finalized the transfer with NACK (=stop condition).



Fig.12 Measurement Request Command

2) Data Fetch(DF)

The DF command is began by the micro-controller (master) as sending address(7bit : 0x28) and read bit (1bit : 1). The real signal is 0x51. The HT-01S sends back an acknowledgement (ACK) to indicate success. The others data are two status bit and measurement data with humidity and temperature to sending a NACK (= stop condition) by the master. The first two bytes of measurement data contain the two status bits as MSB, and then followed by the humidity value with 14 bits.

If the temperature data is also needed, then these can be read after the humidity value. The most significant 8 bits of the temperature value will be transferred as third byte. Then the least significant 6 bits of the temperature value can be read as the fourth byte. The last two bits are not used and should be masked away. But if the temperature data is not needed, the master can send a NACK signal. If it doesn't appear "state bit 00", does not communicate.

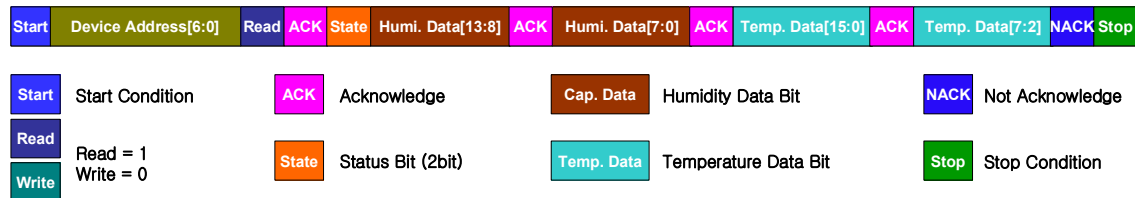

Fig.13 Measurement Packet Reads

Status Bit Table

Status Bits	Output	Definition
00B	Clipped normal output	Data that has not been fetched since the last measurement cycle.
01B	Not applicable	Data that has already been fetched since the last measurement cycle.
10B	Not used	Not used
11B	Not used	Not used

3) Relative Humidity and Temperature Raw Data Collection

Raw data are collected for the HT-01S. The Raw data should also be the average of several samples to minimize noise effects. To collect relative humidity and temperature raw data in measurement, the expression as follows;

The Humidity_High and Humidity_Low bytes can be read in %.

$$\text{Humidity [\%RH]} = (\text{Humidity_High}[5:0] \times 256 + \text{Humidity_Low}[7:0]) / 2^{14} \times 100$$

The Temp_High and the Temp_Low bytes can be read as temperature output in °C.

$$\text{Temp output [C]} = (\text{Temp_High}[7:0] \times 64 + \text{Temp_Low}[7:2]/4) / 2^{14} \times 165 - 40$$

Using bit range [MSB:LSB]