

14 Watt DC/DC Converter using Integrated Inductive Components

Application Note

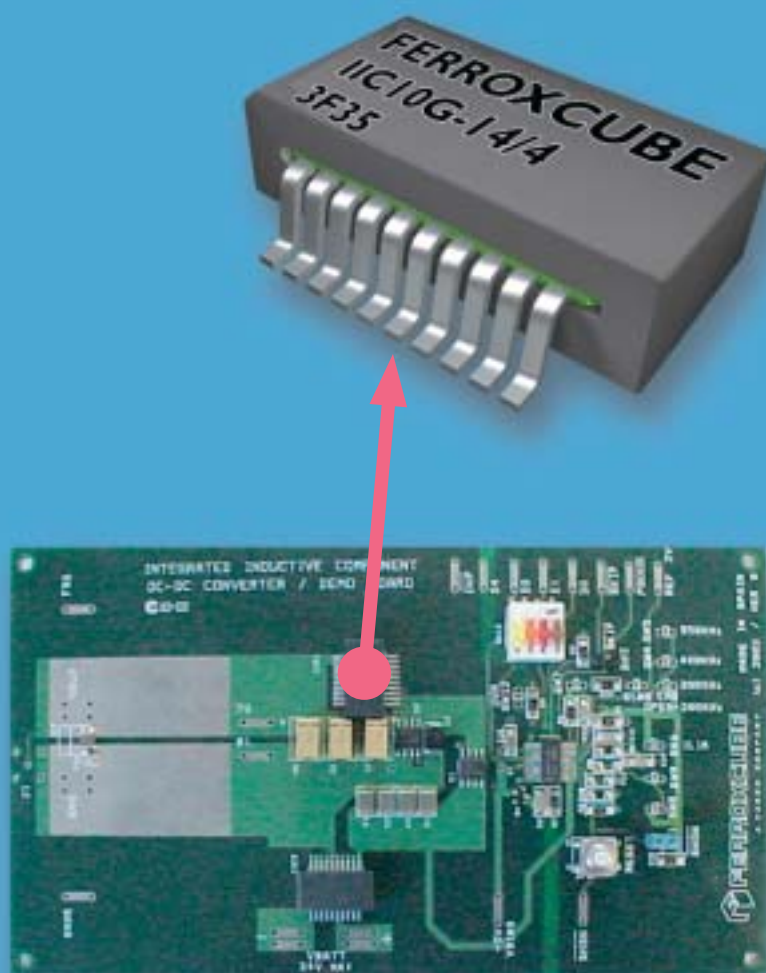

14Watt DC/DC Converter using Integrated Inductive Components

Summary

In compact step down converters, bobbin cores are often used as output inductor. A reference circuit has been modified in order to substitute a bobbin core by a fully gapped IIC. This component is designed to carry currents up to 7A at 300 kHz without saturating. The chosen component is an IIC in 3F35 material with a 0.2 mm full gap. The winding has five turns designed on a PCB with 1.7 mm double tracks in order to reach the required low DC resistance. 3F35 material has been selected due to the switching frequency. For other requirements in switching applications, FERROXCUBE's Integrated Inductive Components are also available in other power materials such as 3C30, 3C96 and 3F4.

Compared to the original component in the circuit, a bobbin core (Coiltronics UP4B-2R2), the IIC shows some distinct advantages with respect to board area and build height.

This demo design shows that Integrated Inductive Components are very suitable for use in modern high frequency DC/DC converters.

Contents

Introduction	3
IIC Features	3
General product data	4
Ferrite material characteristics	5
Product characteristics	6
Design of IIC inductors	8
Demo board description	11
Circuit waveforms	13

Annex A

- Magnetic radiation	14
----------------------	----

Annex B

- Circuit schematic	17
- PCB layout	18
- Component list	19

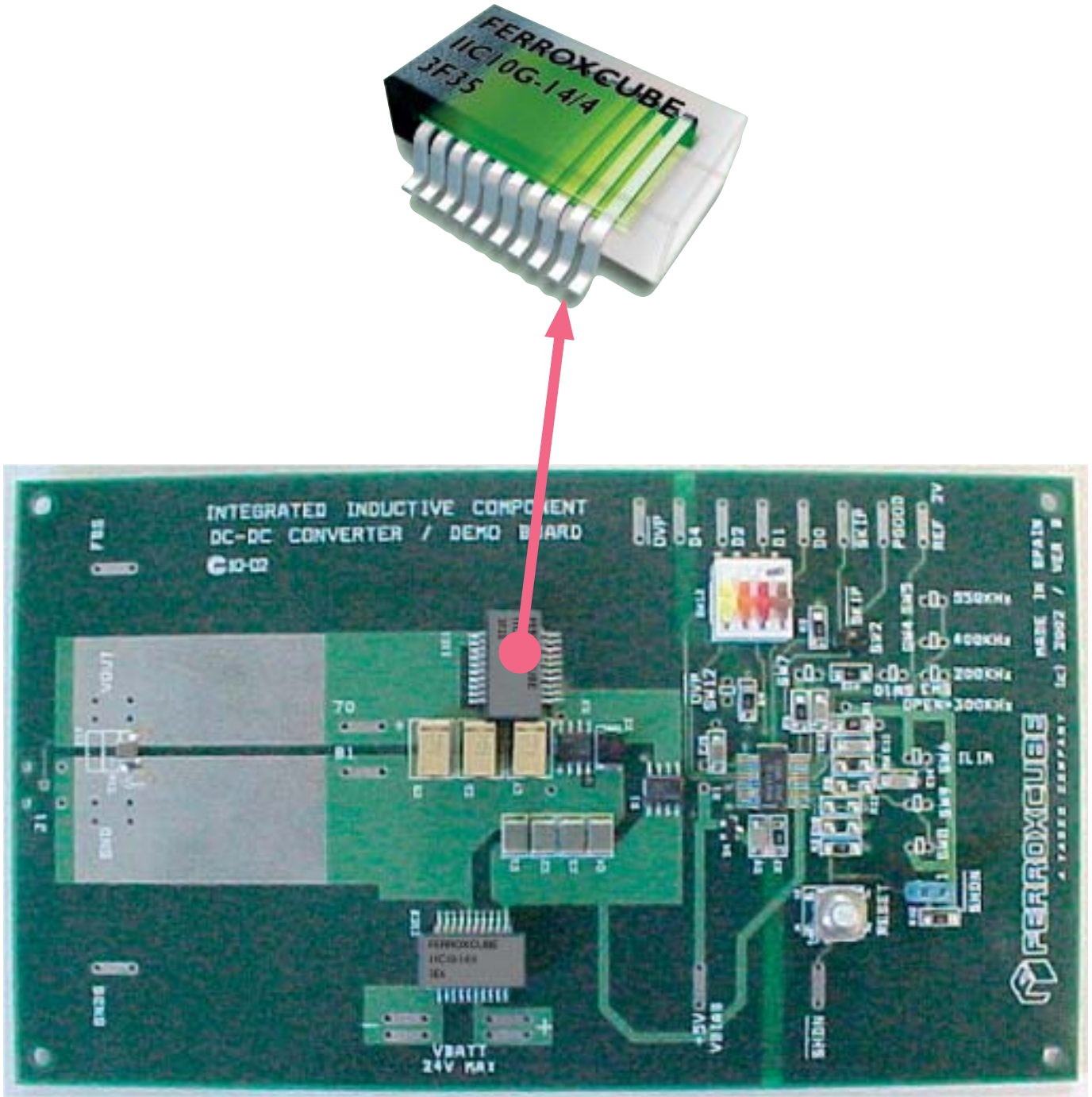

Fig. 1 DC converter demo board with 2 IICs

Introduction

Today's power designs demand low profile components but withstanding high power densities. Integrated Inductive Components (IIC) are ideal for DC-DC converter applications due to their compact size and advanced gap technology.

Its 4.4 mm maximum height make IICs attractive inductors to apply in DC-DC converters for notebook computers, PC motherboards, battery to core converters, distributed power systems and portable electronics.

Gapped versions allow a very accurate and constant inductance up to high currents densities, and also reduce temperature influence.

The geometry of the Integrated Inductive Component (IIC) based on a magnetically closed path reduces the incidence of unwanted radiation of the magnetic field. This radiation, which depends on the current through the inductor, can affect signals in nearby circuits and in other components.

This application note shows the performance of an Integrated Inductive Component (IIC) with a full gap in a step down DC-DC converter. The configuration of the windings (number of turns and PCB tracks) has a special design to keep its DC resistance low.

IIC Features

- **Low profile component (max height 4.4 mm).**
- **Leads bent in a so-called gull wing shape.**
- **Handled by standard pick and place equipment.**
- **Soldered together with other ICs by reflow.**
- **Number of turns configurable on the PCB.**
- **200/400/1000/2000 kHz switching frequency (different power materials available).**
- **Other possible functions with other materials/configurations (e.g. 3E6 for common-mode choke).**
- **Very low radiated emission.**
- **High saturation, high inductance and low power loss materials.**



General product data

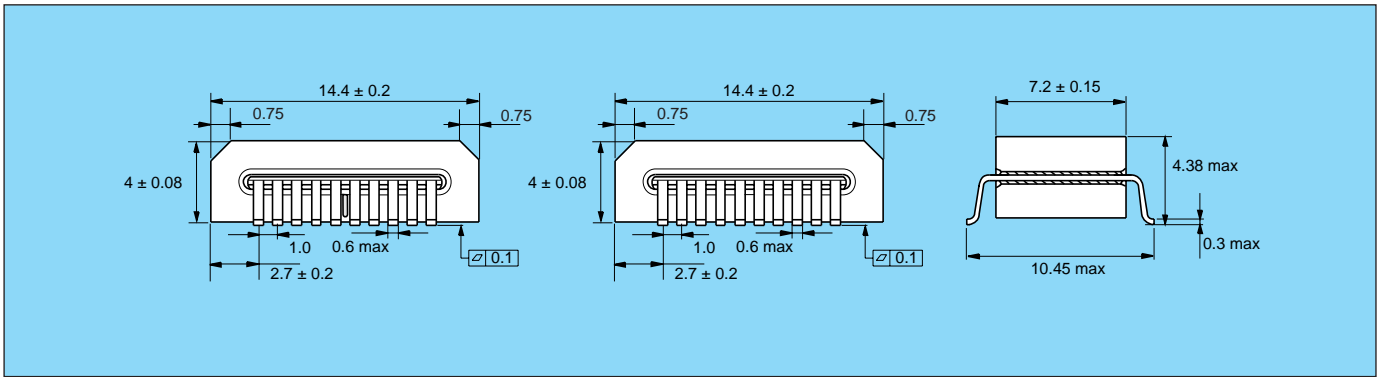

Fig.2 IIC10P-14/4 and IIC10-14/4 outline

SYMBOL	PARAMETER	VALUE	UNIT
$\Sigma(l/A)$	core factor (C1)	2.47	mm ⁻¹
V_e	effective volume	338	mm ³
l_e	effective length	28.9	mm
A_e	effective area	11.7	mm ²
m	mass	≈ 1.85	g

General data

Lead frame material:
copper, plated with tin-lead alloy (SnPb 85/15)

Solder ability:
- compatible with reflow soldering
- IEC 68-2-58, part 2, test Ta, method 1

Moulding material:
liquid crystal polymer (LCP), flame retardant in accordance with UL 94V-0

Isolation voltage:
> 500 V_{dc} between leads and between leads and ferrite core

Isolation resistance:
>100 MΩ between leads

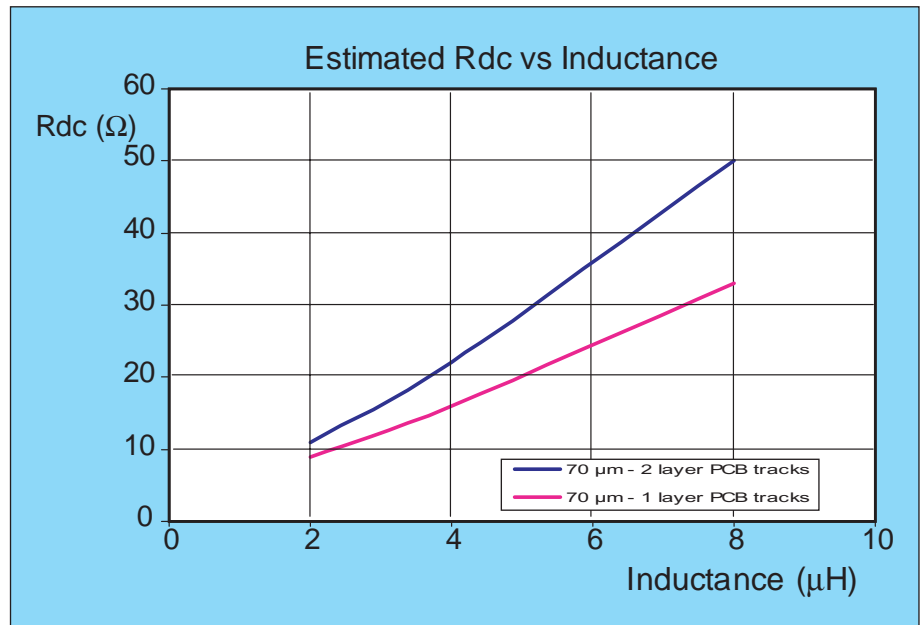

Ferrite material characteristics

3F35 specifications

SYMBOL	CONDITIONS	VALUE	UNIT
μ_i	25 °C; 10 kHz; 0.1 mT	1400 ±20%	
μ_a	100 °C; 25 kHz; 200 mT	≈ 2400	
B	25 °C; 10 kHz; 250 A/m 100 °C; 10 kHz; 250 A/m	≈ 450 ≈ 370	mT
P_v	100 °C; 400 kHz; 50 mT 100 °C; 500 kHz; 50 mT 100 °C; 500 kHz; 100 mT	≈ 60 ≈ 90 ≈ 700	kW/m ³
ρ	DC; 25 °C	≈ 10	Ωm
T_c		≥ 240	°C
density		≈ 4750	kg/m ³

3E6 specifications

SYMBOL	CONDITIONS	VALUE	UNIT
μ_i	25 °C; 10 kHz; 0.1 mT	1200 ±20%	
B	25 °C; 10 kHz; 250 A/m 100 °C; 10 kHz; 250 A/m	≈ 380 ≈ 210	mT
$\tan\delta/\mu_i$	25 °C; 10 kHz; 0.1 mT 25 °C; 30 kHz; 0.1 mT	≤ 10x10 ⁻⁶ ≤ 30x10 ⁻⁶	
η_B	25 °C; 10 kHz; 1.5 to 3 mT	≤ 1x10 ⁻³	kW/m ³
ρ	DC; 25 °C	≈ 0.1	Ωm
T_c		≥ 130	°C
density		≈ 4900	kg/m ³

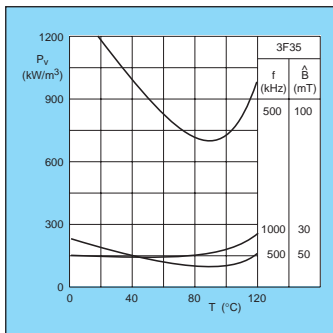
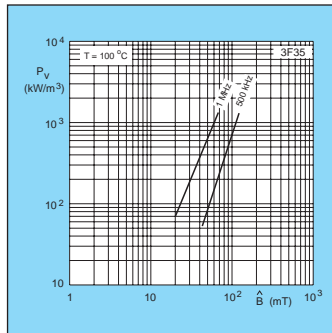
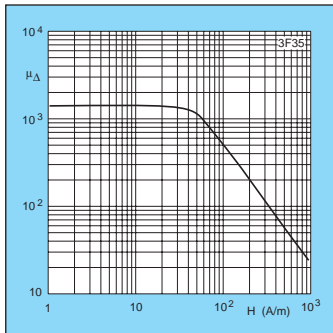
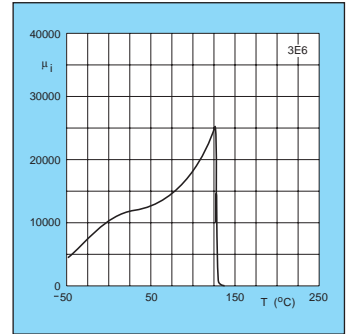
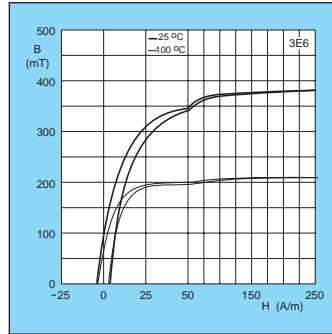
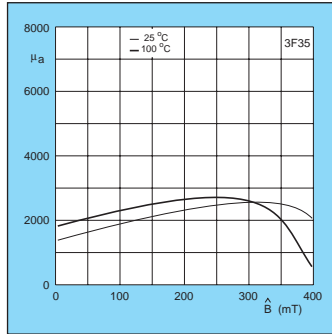
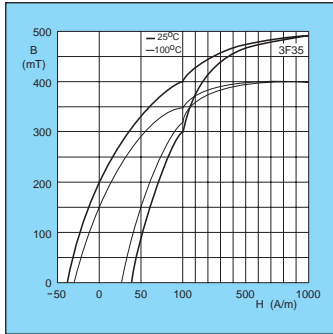
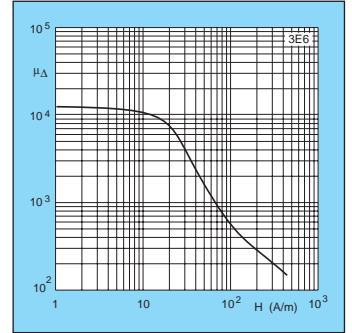
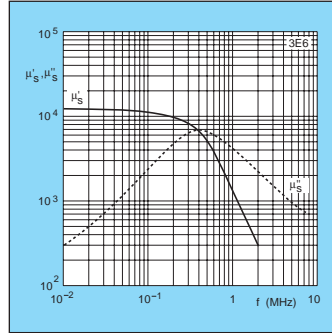
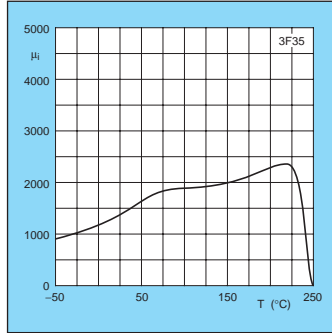
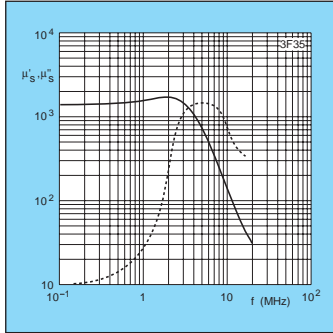

Product Characteristics

IIC10G-14/4-3F35 (full gap)

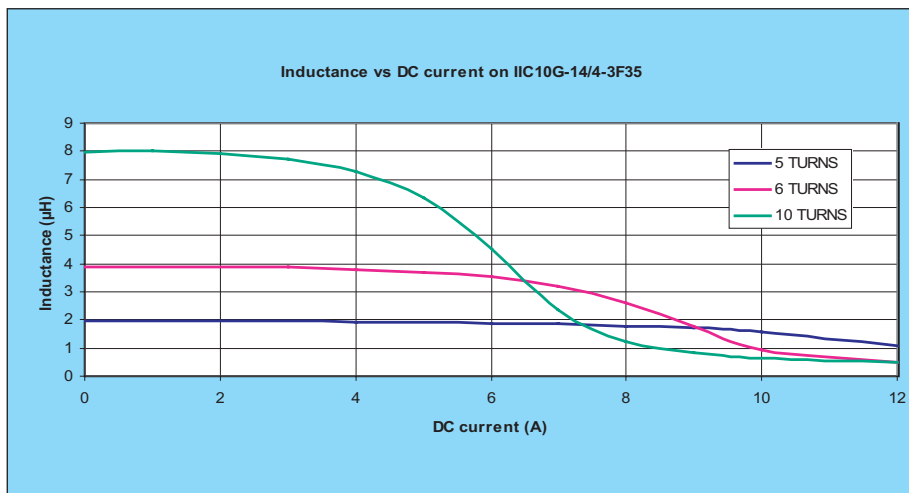

IIC10G-14/4-3C30 (full gap)

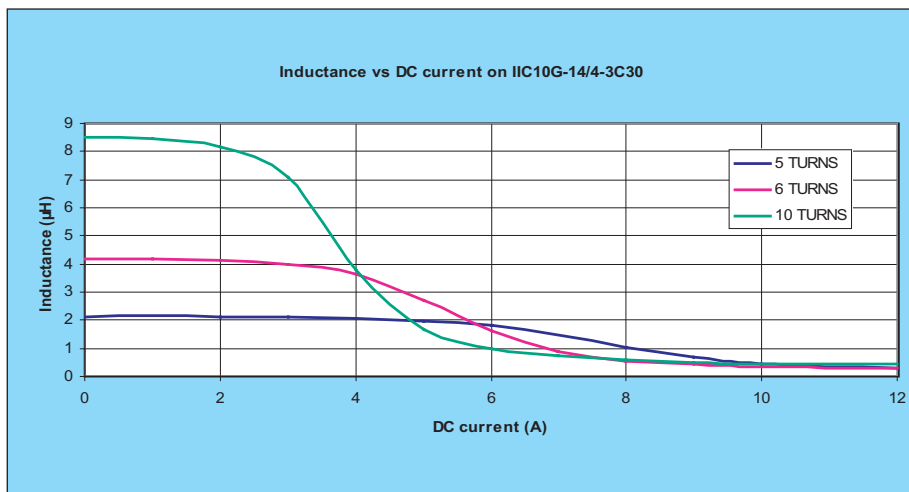

IIC10G-14/4-3F4 (full gap)

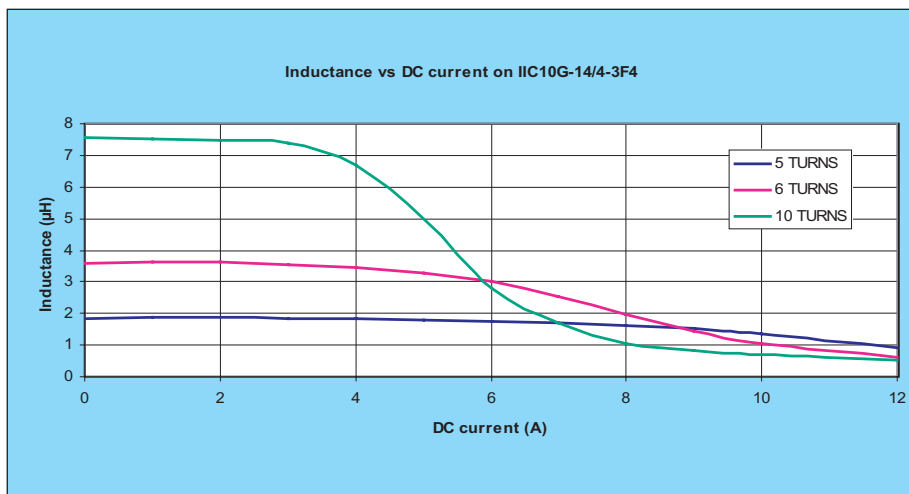

IIC10P-14/4-3F35 (partial gap)

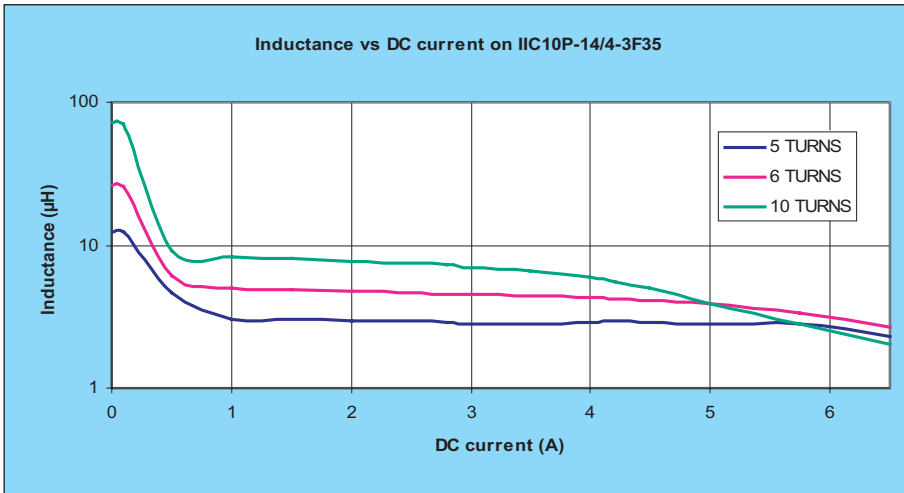

IIC10P-14/4-3C30 (partial gap)

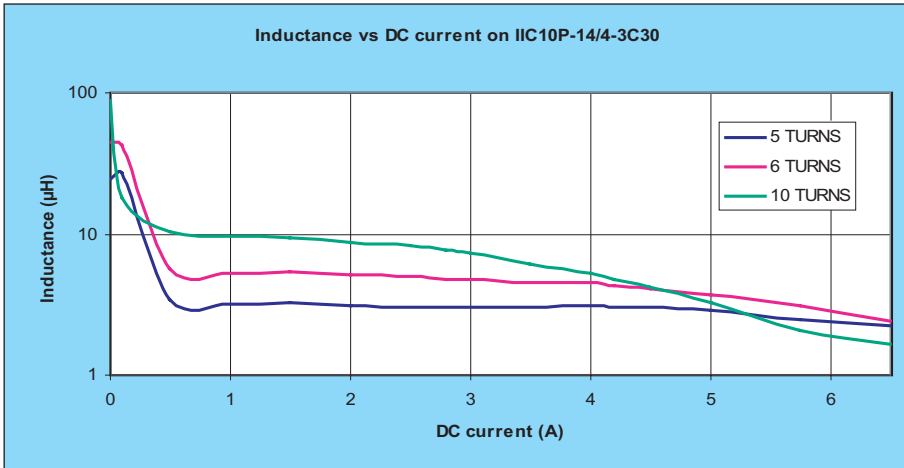

IIC10P-14/4-3F4 (partial gap)

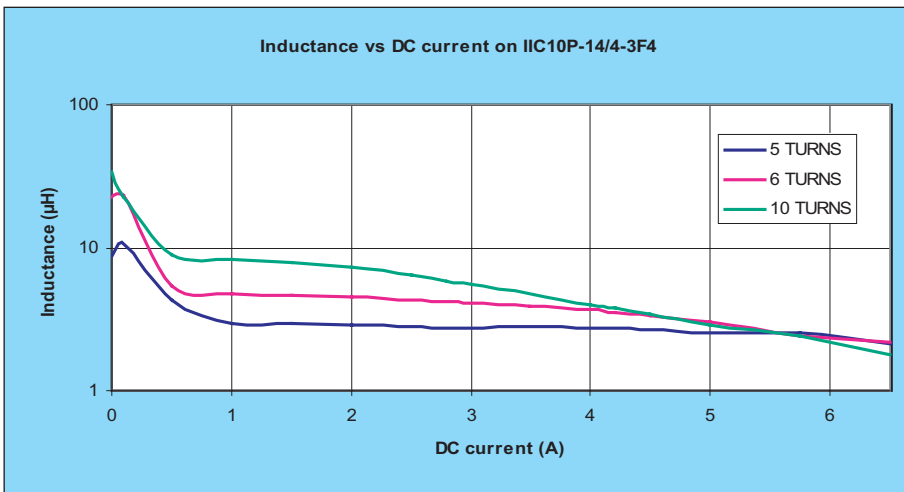

Design of IIC inductors

OUTPUT INDUCTOR

Figure 3 shows the basic circuit of a DC-DC converter with associated waveforms. When the switch is closed (transistor S conducts), the current rises linearly and flows through the inductor into the capacitor and the load. During the ON cycle, energy is transferred to the output and stored in the inductor. When the switch is opened (OFF cycle), the energy stored in the inductor causes the current to continue to flow to the output via the diode. The output voltage can be calculated as:

$$V_o = \frac{t_{on}}{T_s} V_i = DV_i$$

where t_{on} is the time while the switch is conducting, T_s is one period of the switching signal and D is the duty cycle.

The amount of energy stored in the inductor can be varied by controlling the ON/OFF cycles.

$$I_{L(avg)} = \frac{1}{T_s} \int_0^{T_s} i_L(t) dt$$

$$= \frac{1}{T_s} \left[\int_0^{t_{on}} i_L(t) dt + \int_{t_{on}}^{T_s} i_L(t) dt \right]$$

Looking at the current shape through the inductor in figure 3, the inductor ripple current can be calculated as:

$$I_L = i_{L(max)} - i_{L(min)} = \frac{V_o}{L} (1 - D) T_s$$

The minimum practical inductor value causes the circuit to operate at the edge of critical conduction, where the inductor current just touches zero with every cycle at maximum load. This choice is a trade-off between size and efficiency. Low inductor values cause large ripple currents, resulting in the smallest core size, but poor efficiency and high output noise.

Assuming that all of the ripple component in i_L flows through the output capacitor it causes an additional charge ΔQ in the capacitor resulting in a peak to peak voltage ripple ΔV_o at the output.

$$\Delta V_o = \frac{\Delta Q}{C} = \frac{\Delta I_L T_s}{8C}$$

The switching frequency and operating point (% ripple or LIR) determine the inductor value as follows:

$$L = \frac{V_o(1 - D)}{f_s \cdot LIR \cdot I_{o(MAX)}}$$

where $D = V_o/V_i$ in continuous mode (current through the inductor is always higher than zero).

Example:

$V_i = 24V, V_o = 2V, I_{o(MAX)} = 7A,$
 $f_s = 300kHz, 50\% \text{ ripple current}$
 or $LIR = 0.5$.

$$L = \frac{2V(1 - 0.083)}{300kHz \cdot 0.5 \cdot 7A} = 1.75\mu H$$

Maximum peak current through the inductor can be increased up to 7A. For that reason, DC resistance of the winding should be kept as low as possible to prevent high winding losses in the inductor.

$$P_{dc} = I^2 R_{dc}$$

The DC resistance of the winding can be calculated from the cross section and length of the copper tracks and are shown in the graph on page 4. Note that double tracks results in half the DC resistance.

$$R_{dc} = \rho \frac{l}{S}$$

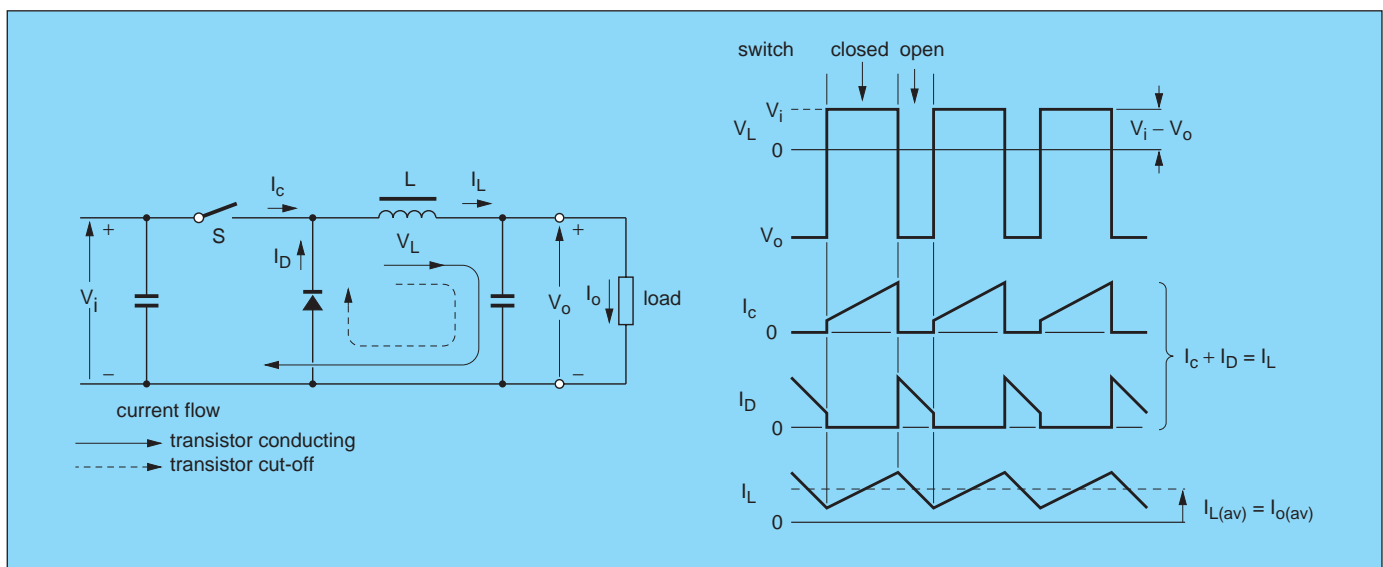

Fig. 3 Basic circuit of a DC-DC converter with associated waveforms.

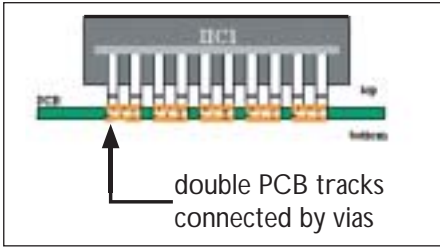

Fig. 4 IIC on board (5 turns).

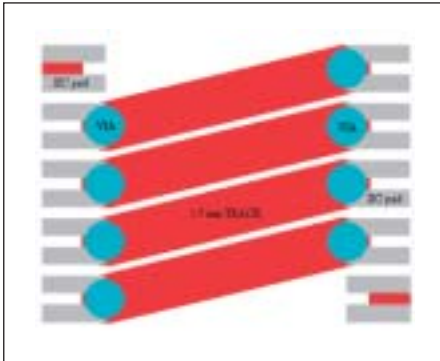

Fig. 5 Recommended layout for 5 turns (top view).

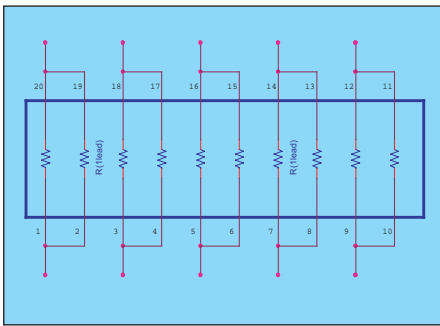

Fig. 6 Equivalent electrical circuit (5 turns).

Example and recommended PCB layout for IIC winding.

$I_{o(MAX)} = 7A$
 number of turns = 5
 thickness of the PCB copper = 70 μm per layer

In this case the IIC should have 5 turns. As the IIC has 10 leads, every two leads are connected in parallel with solder pads to achieve 5 turns. The windings are closed through the PCB tracks. To increase the copper cross section of the tracks and to reduce the DC resistance, the tracks are arranged in both top and bottom layer of the PCB and connected through vias (figure 4).

The width of every track is 1.7 mm (figure 5) and the thickness is 70 μm . The length of every track is 9.3 mm but as there are tracks in two layers connected with vias, the thickness can be considered as double (140 μm).

The total DC resistance is the sum of the resistance of the IIC leads, the four doubled tracks and the eight vias plus soldering contacts.

$$R_{dc} = R_{dc(IIC)} + R_{dc(tracks)} + R_{dc(vias+contacts)}$$

where

$$R_{dc(tracks)} = 4 \cdot 17 \cdot 10^{-6} \Omega mm \frac{9.3mm}{2 \cdot 70 \cdot 10^{-3} \cdot 1.7mm^2} = 2.66m\Omega$$

To calculate the contribution of the IIC leads, the resistance of 1 lead (1.15 m Ω) and the electrical circuit must be taken into account. The equivalent electrical circuit for this case (winding of five turns) is shown in figure 6.

To set up five turns, every two leads are connected, so two resistors are in parallel per turn. Turns are closed through the PCB layout. The DC resistance of the IIC leads can be calculated as 5 times the parallel value of two leads:

$$R_{dc(IIC)} = 5 \cdot (R_{(lead)} // R_{(lead)}) = 5 \cdot \left(\frac{1.15 \cdot 10^{-3} \cdot 1.15 \cdot 10^{-3}}{1.15 \cdot 10^{-3} + 1.15 \cdot 10^{-3}} \right) = 2.88m\Omega$$

The total resistance of the output inductor results in:

$$R_{dc} = R_{dc(IIC)} + R_{dc(tracks)} + R_{dc(vias+contacts)} = 2.88m\Omega + 2.66m\Omega + 3m\Omega = 8.54m\Omega$$

It was found empirically that the resistance caused by the eight vias and the soldering contacts is around 3m Ω

Now the maximum dissipated power can be calculated as:

$$P_{dc(max)} = (7A)^2 \cdot 8.56 m\Omega = 0.42W$$

For a fixed number of turns, the inductance can be calculated as:

$$L(nH) = A_L \cdot N^2$$

COMMON-MODE CHOKE

To avoid conduction of switching noise from an SMPS to the mains, an input filter is generally necessary. Since the noise signal is mainly common mode, current compensation can be used to avoid saturation. (Fig 7A)

Differential currents cause fluxes that cancel out, the impedance presented by the choke is practically zero. This leaves the differential signal passing through the choke unattenuated. Common mode noise, however, causes common mode currents. These current flows in the same direction in the two windings creating equal and in phase magnetic fields. The choke shows high impedance to the common mode current and causes attenuation.

To test the noise attenuated by the common mode choke a precision spectrum analyser should be used. That equipment gives noise readings against frequency in dB μ V units.

$$Noise(dB\mu V) = 20 \log_{10} \left(\frac{V}{1\mu V} \right)$$

The noise can be written in natural units (volts):

$$V(volts) = \left(10^{\frac{Noise(dB\mu V)}{20}} \right) 10^{-6}$$

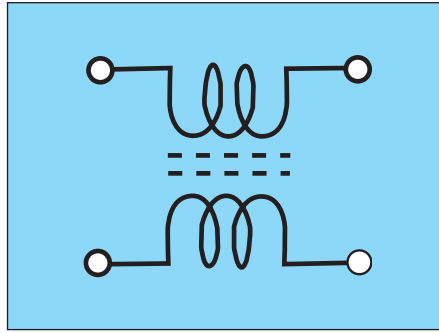

Fig. 7 Equivalent circuit for a common mode choke.

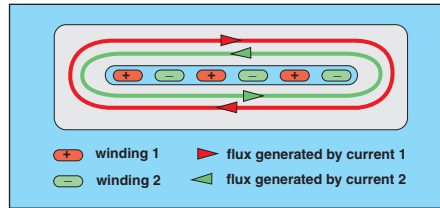

Fig. 7A Flux cancelling in a common mode choke.

Demo board description

The 14 W DC-DC converter demo board demonstrates the performance of the IIC as output inductor and common mode choke. This converter is intended to step down voltages from batteries and/or AC adapters, generating a precision low output voltage.

Most of the output inductors used for this kind of converters are drum cores like UP4B-2R2 from Coiltronics. IIC, having the same electrical performance as these drum cores shows some distinct advantages.:

Benefits from IIC	IIC	Drum Core
Smaller area	14.5 mm x 12.4 mm = 179.8 mm ²	26 mm x 17 mm = 442 mm ²
Lower height	4.4 mm	7.87 mm
Repeatability of performance	Leads automatically assembled. Turns arranged on PCB.	Turns arranged by hand.

Table 1 Benefits from IIC.

The output inductor is an IIC in 3F35 with a 0.2 mm full gap. This component withstands up to 7A at 300 kHz without saturating. The winding has five turns designed on a PCB with 1.7 mm double tracks in order to reach a low DC resistance. 3F35 material has been selected due to the switching frequency. For other requirements in switching frequency, different power material are like 3C30, 3C96 or 3F4 are available.

A second IIC has been included in the demo board. This is a non-gapped IIC in 3E6 material working as common mode choke in the battery line to filter the noise caused by the square wave switching signals that trigger the power MOSFET transistors. It has two windings of five turns each designed to compensate current peaks that can affect the battery line and also other components. 3E6 and 3S4 are high impedance materials recommended for this application.

This demo board is a fully assembled and tested circuit.

The 7A buck-regulator is optimized for 300 kHz and an output voltage setting around 1.6 V.

The PC board layout deliberately includes long output power and ground buses in order to facilitate the evaluation of the circuit and to

provide space for soldering different types of output filter capacitors. In a commercial design the outline dimensions of the board could be reduced to 33 mm x 33 mm x 6.5 mm. With these dimensions, the power density that could be achieved is **1.50 W/cm³**. Also note that the board includes some components like switches and jumpers that are needed to test the circuit in an easy way, but these components would not be included in a real application, where the total area is reduced. The components with the maximum height are the output tantalum capacitors. A typical drum core is higher than these capacitors while the IIC keeps the same height.

CONVERTER SPECIFICATION	
Nominal output power	11 W
Maximum output power	14 W
Load current	5.5 A continuous (7 A peak)
Output voltage range	1.25 V to 2 V
Input voltage range	7 V to 24 V
Switching frequency	300 kHz
Efficiency	≈90 % (V _{out} = 2 V, V _{batt} = 7 V, I _{load} = 4 A)
Output voltage ripple	≈1.1% (V _{ou t} = 2 V, V _{batt} = 7 V, I _{load} = 4 A)
Outline dimensions	150 mm x 86 mm

Table 2 Converter specification.

EQUIPMENT NEEDED

- 7V to 24 V, >20 W power supply.
- DC bias power supply, 5 V/100 mA.
- Active load capable of sinking 7A.
- Digital multi meter.
- 100MHz dual-trace oscilloscope.

QUICK START

1. Connect the 5 V DC bias power supply to the "+5V VBIAS" and "GND" terminals.
2. Connect the 20V power supply to the battery line: "VBATT MAX".
3. Connect the active load to the "VOUT" and "GND" terminals.
4. Ensure that the shunt is connected at SW1 (SHDN = Vcc).
5. Turn on battery power prior to +5 V bias power.
6. Do not change the DAC code without cycling +5 V bias power; otherwise, the output voltage ramp will probably bump into the over- or under voltage protection thresholds and latch the circuit off. If this happens, just cycle power or **press the RESET button**.
7. Set switch SW13 per Table 3 to get the desired output voltage.

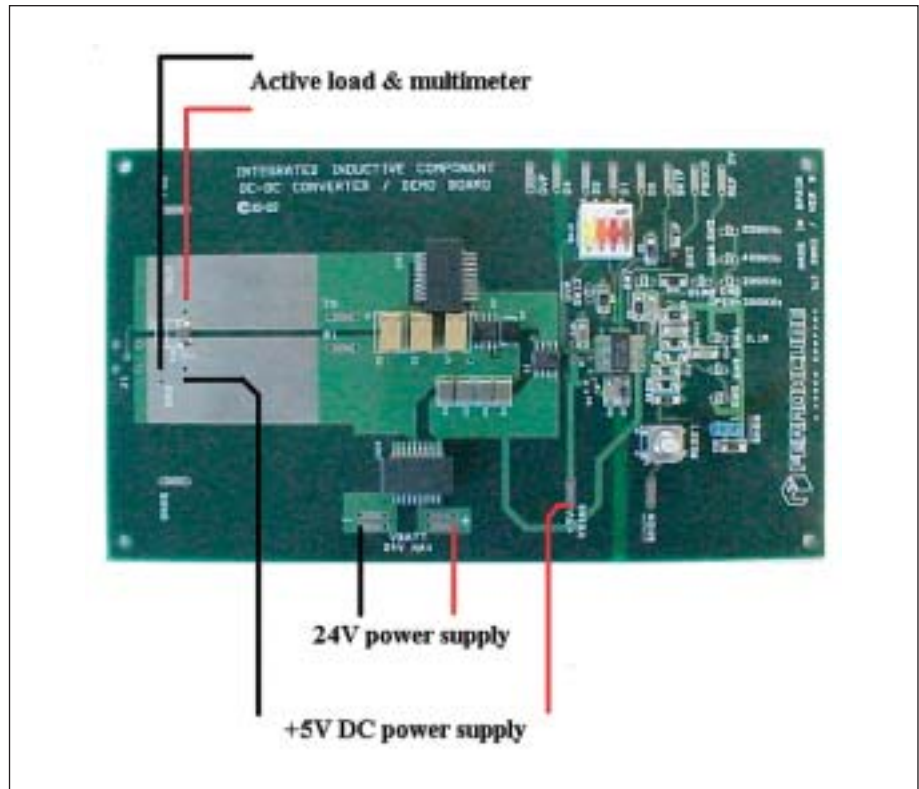

Fig. 8 Quick start connection.

D3	D2	D1	D0	Output Voltage (V)
0	0	0	0	2.00
0	0	0	1	1.95
0	0	1	0	1.90
0	0	1	1	1.85
0	1	0	0	1.80
0	1	0	1	1.75
0	1	1	0	1.70
0	1	1	1	1.65
1	0	0	0	1.60
1	0	0	1	1.55
1	0	1	0	1.50
1	0	1	1	1.45
1	1	0	0	1.40
1	1	0	1	1.35
1	1	1	0	1.30
1	1	1	1	1.25

Table 3 Output voltage settings.

EFFICIENCY MEASUREMENT

Efficiency measurements requires more careful instrumentation than might be expected. Do not use only one digital multi meter. A common error is to move it from one spot to another to measure the various input/output voltages and currents. This results in changing the exact conditions applied to the circuit due to series resistances in the ammeters. It's better to monitor V_{BATT} , V_{OUT} , I_{BATT} and I_{LOAD} simultaneously, using separate test leads directly connected to the input and output board terminals.

The power consumed by the +5 V bias supply must be included to make efficiency calculations:

$$Efficiency = \frac{V_{OUT} \cdot I_{LOAD}}{(V_{BATT} \cdot I_{BATT}) + (5V \cdot I_{BIAS})}$$

CIRCUIT WAVEFORMS

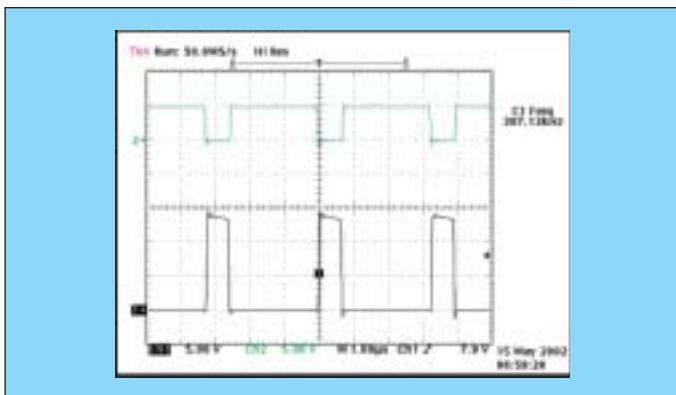

Gate drive for top MOSFET D1 and lower MOSFET D2 (Fig. 9)

PWM signals to drive the MOSFETs.

Circuit conditions:

$V_{out} = 2\text{ V}$.

$I_{out} = 3\text{ A}$.

$V_{batt} = 8.6\text{ V}$

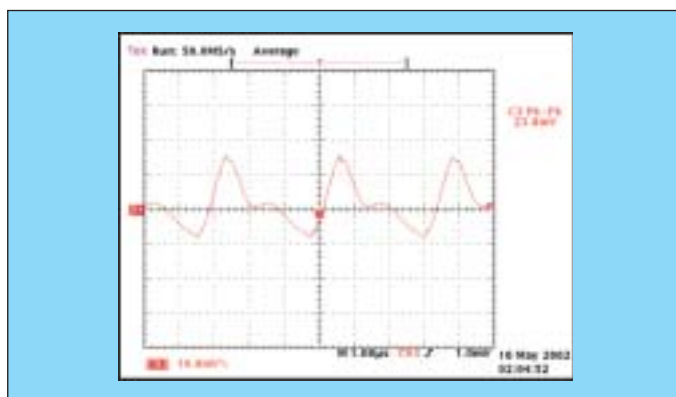

Output voltage ripple. (Fig. 10)

AC content of the output voltage.

Circuit conditions:

$V_{out} = 2\text{ V}$.

$I_{out} = 3\text{ A}$.

$V_{batt} = 8.6\text{ V}$.

$V_{out\ ripple} = 23.8\text{ mV}$.

The voltage ripple does not depend on the load current since the inductance value is constant.

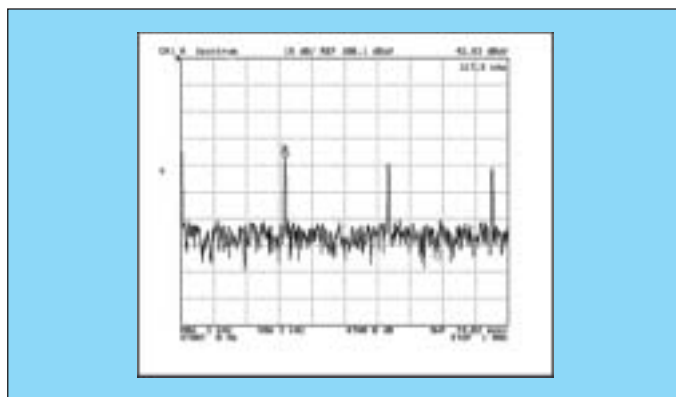

Noise at the battery line without common mode choke. (Fig. 11)

Noise spectrum from DC to 1 MHz.

Circuit conditions:

$V_{out} = 2\text{ V}$.

$I_{out} = 5\text{ A}$.

$V_{batt} = 12\text{ V}$.

Noise at the switching frequency (317.5 kHz): 42.83 dB μ V

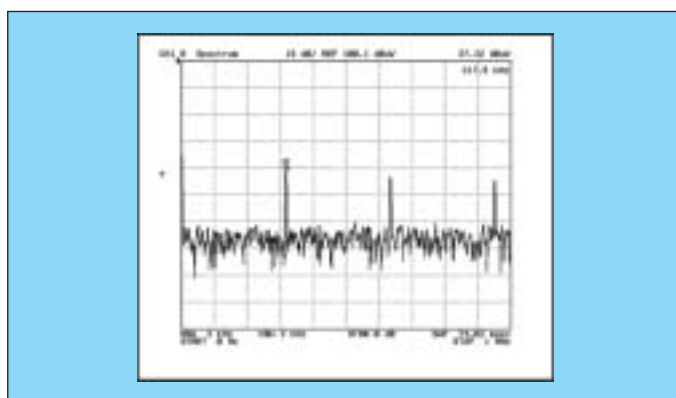

Noise at the battery line including the common mode choke. (Fig. 12)

Noise spectrum from DC to 1MHz.

Circuit conditions:

$V_{out} = 2\text{ V}$.

$I_{out} = 5\text{ A}$.

$V_{batt} = 12\text{ V}$

Noise at the switching frequency (317.5 kHz): 37.32 dB μ V. Noise is reduced to the half in natural units

Annex A

Magnetic radiation

The miniaturization trend has resulted in smaller components and greater board densities in electronic applications. This very density, which “packs” components into ever-smaller spaces, makes it more important than ever to examine the effect—including possible damage—each component may have on signals in nearby circuit paths and on other components. This application note examines the way in which the geometry of magnetic components, such as inductors or transformers, may affect the incidence of unwanted, low-frequency radiation of the magnetic field. In the following experiment, commercially available inductors are used as an output choke in a DC/DC converter. Two types of inductors are used; bobbin cores which have magnetically-open paths and an Integrated Inductive Component (IIC) from FERROXCUBE with a full gap and a magnetically closed path.

Magnetic path

The electrical properties of magnetic components, such as transformers and inductors, are based on three main parameters:

- The winding that transforms the electric current into a magnetic field
- The magnetic properties of the material, such as magnetic permeability, that determine the magnetic flux induced by the magnetic field.
- The shape of the component that determines the path of the magnetic field.

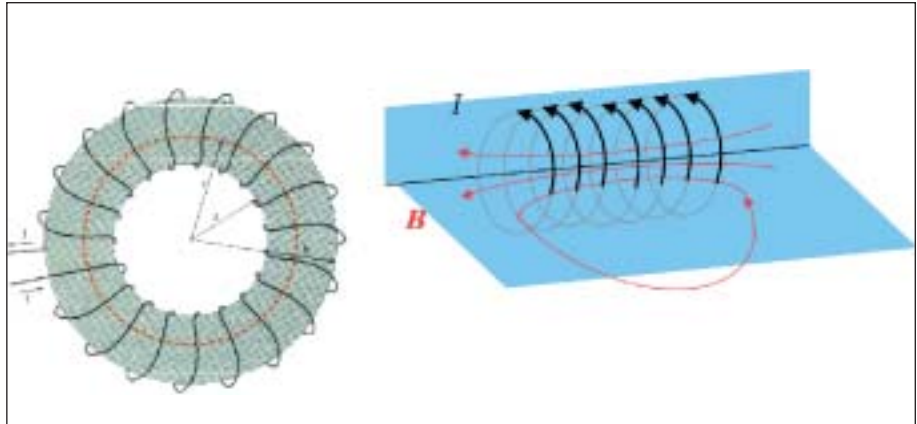

Fig. A1 Flux distribution in a toroid (closed magnetic circuit) where no radiation can be noticed, and in a rod (open magnetic circuit) with radiation leaving the product.

The relationship between these 3 parameters will determine the basic properties of the magnetic component. With relatively simple formulas, it is possible to calculate the inductance, maximum current, and power loss of the inductor. These are the most important electrical parameters needed to design a component for a given application. Also, the geometry of the component will influence the “radiation capability” of the magnetic component, a capability uninfluenced by any of the electrical parameters used in the design. For a clearer understanding of the crucial role of geometry for radiated emissions, magnetic components can be broken into two groups. First, in closed magnetic circuits, the magnetic flux remains inside the magnetic core, and most of the magnetic-field lines are closed lines surrounded by the winding. A good example of this first geometry is a toroid (Figure 1). Second, in open magnetic circuits, the magnetic flux flows briefly in the magnetic core and then through the ambient air. Sometimes most of their length is not within the magnetic core but passes through the surroundings,

thereby crossing conductors or other components. An example of the second geometry is a rod (Figure 1). In fact, there are many geometric configurations that will lead to designs that “radiate” to a greater or lesser extent depending on just how “open” they are. The products examined in this article are two examples of the aforementioned geometries and show similar electrical properties. Inductance is about 5 μH , DC-resistance below 10 $\text{m}\Omega$, saturation current of approximately 7 A for the Integrated Inductive Component and approximately 10 A for the bobbin core. They have similar volumes: the IIC is about 576 mm^3 , and the bobbin core is about 650 mm^3 (Figure 2).



Fig. A2 Integrated inductive Component (left) and a bobbin core.

Why is magnetic radiation an issue?

In many power applications, such as power conversion, magnetic components are subjected to high currents and, consequently, to very high magnetic fields. Depending on the core geometry, magnetic fields may radiate from the inductive device. Such fields are relatively strong in the area near the magnetic components and will couple with any conductor loop present on the PCB close to the component.

This means that harmful switching harmonics can appear anywhere in the circuit, causing radiation, degrading the quality of digital signals, or even damaging sensitive ICs. Functionality may be the first criterion in choosing a component; but ultimately, the equipment containing that component must comply with EMC regulations. Several committees have set limits for both conducted and radiated interference. In Europe, CISPR 16 sets forth the measuring procedures/methods for such low frequency radiation (9 kHz to 30 MHz). Measurement specifics applicable in the United States can be found in FCC, Part 15.

Test method and experiments

This experiment relies on the so-called "Van Veen method." ¹⁾ Using this method, the device-under-test (DUT) is placed within a loop antenna two meters in diameter. This loop antenna is made of RG223/U coaxial cable with two slits (fitted with a resistor networks) placed symmetrically, each 90° from the current probe. Figure 3 depicts the antenna setup. The current induced in the loop is measured by a current

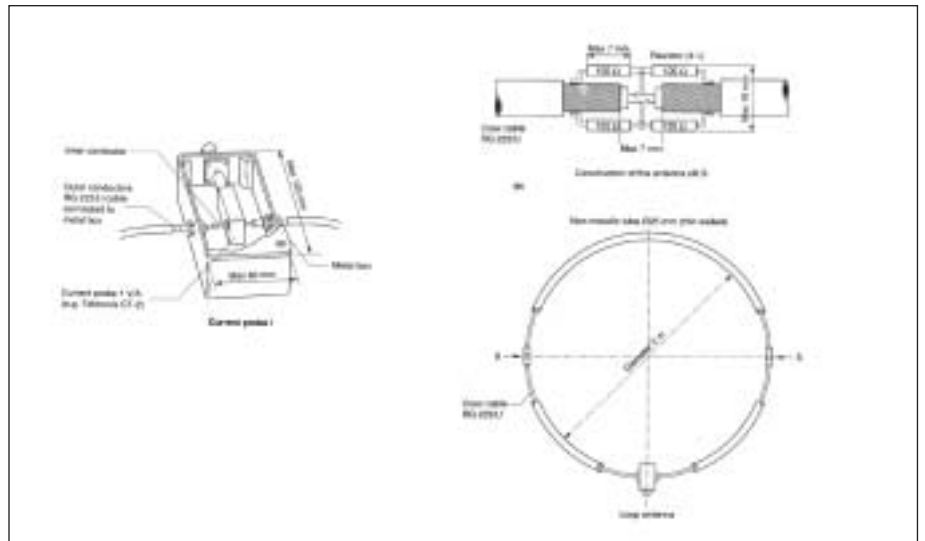

Fig. A3 Antenna loop used to carry out H-field measurements in the range 9 kHz to 30 MHz. The current probe translates the current in the loop to voltage.

probe connected to a spectrum analyzer and is expressed in $\text{dB}\mu\text{A}$. In this test setup, the noise from the environment will be negligible as compared to the currents from the DUT. To check the effect of radiation, the DUT was connected to an RF power amplifier, using a 100 kHz square wave of 2.8 A amplitude. The objective of this experiment is to measure the radiation under similar conditions for both the open magnetic circuit and the closed magnetic circuit. Figure 4 shows the radiation generated by both components expressed in $\text{dB}\mu\text{A}$. These results confirm that open magnetic circuits have much higher radiation levels than closed circuits. Note the amplitude of the harmonics. The difference between the two components is 8 $\text{dB}\mu\text{A}$ at 100 kHz (main frequency) and 6 $\text{dB}\mu\text{A}$ at 300 kHz (third harmonic). Given these figures, it can be derived that the difference in radiation is almost constant, independent of the amplitude of the signal. Consequently, the advantage of using closed magnetic circuits holds in every case

even where radiation is relatively low. The next experiment compared the inductors in a real application, a DC/DC converter, working as an output choke. The converter is a standard design and the operating test conditions were as follows: 2.3 V output voltage delivering 2 A and a switching frequency of 600 kHz. The results given in Figure 5 clearly depict the advantage of using the integrated inductive component versus the drum core. When the IIC is used, radiation levels stay within the radiation values of the overall system. In the case of the bobbin core spikes are measured at 600 and 1800 kHz. A comparison between Figures 4 and 5 shows that the radiation of the DC/DC converter is 5 $\text{dB}\mu\text{A}$, in the frequencies unaffected by the radiation of the inductors.

Annex A

Conclusion

At low frequencies, both conducted and radiated interference should be taken into account. These design principles are necessitated not just by regulatory limits but by the demands for functionality and design integrity in the completed system. Magnetic components with a closed magnetic circuit design (e.g., an Integrated Inductive Component from FERROXCUBE) produce very little or negligible radiation. The use of IICs helps forestall such problems as inducing currents on the tracks, currents that could damage components, and currents that might influence other signals. These closed magnetic circuit devices are, therefore, well suited for use in any kind of equipment where other circuits or PCBs might be affected by magnetic radiation.

References

1. Goedbloed, Jasper J. Electromagnetic Compatibility (CISPR Publication 15). IEC: Geneva, Switzerland: 1992.
2. Ferroxcube Soft Ferrite and Accessories Handbook. 2002

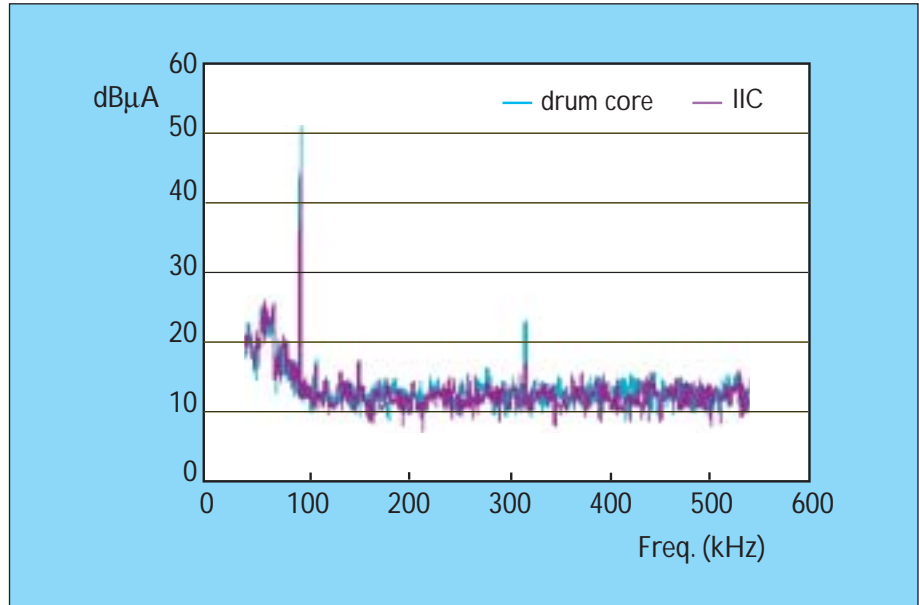

Fig.A4 Radiation on a drum core and a IIC excited with a square wave: 100 kHz, 2.9 Amps peak-peak. The square voltage becomes triangular current when passed across the inductors. The main frequency and the third harmonic can be seen at 100 and 300 kHz.

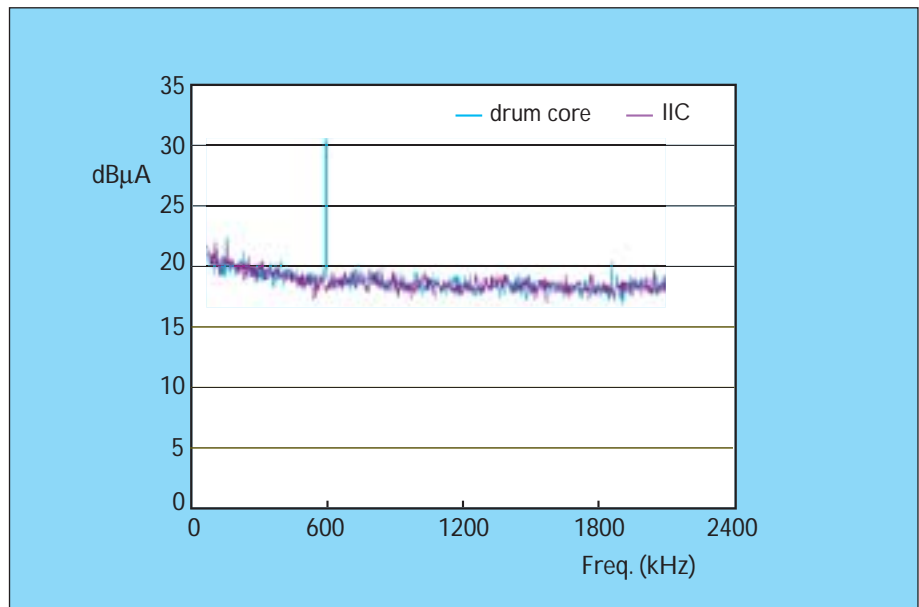

Fig.A5 IIC and drum core working as output choke on a DC/DC converter. IIC shows negligible radiation (comparable with the noise generated by rest of the circuitry) while on the drum core, two harmonics can be seen at 600 and 1800 kHz.

Annex B

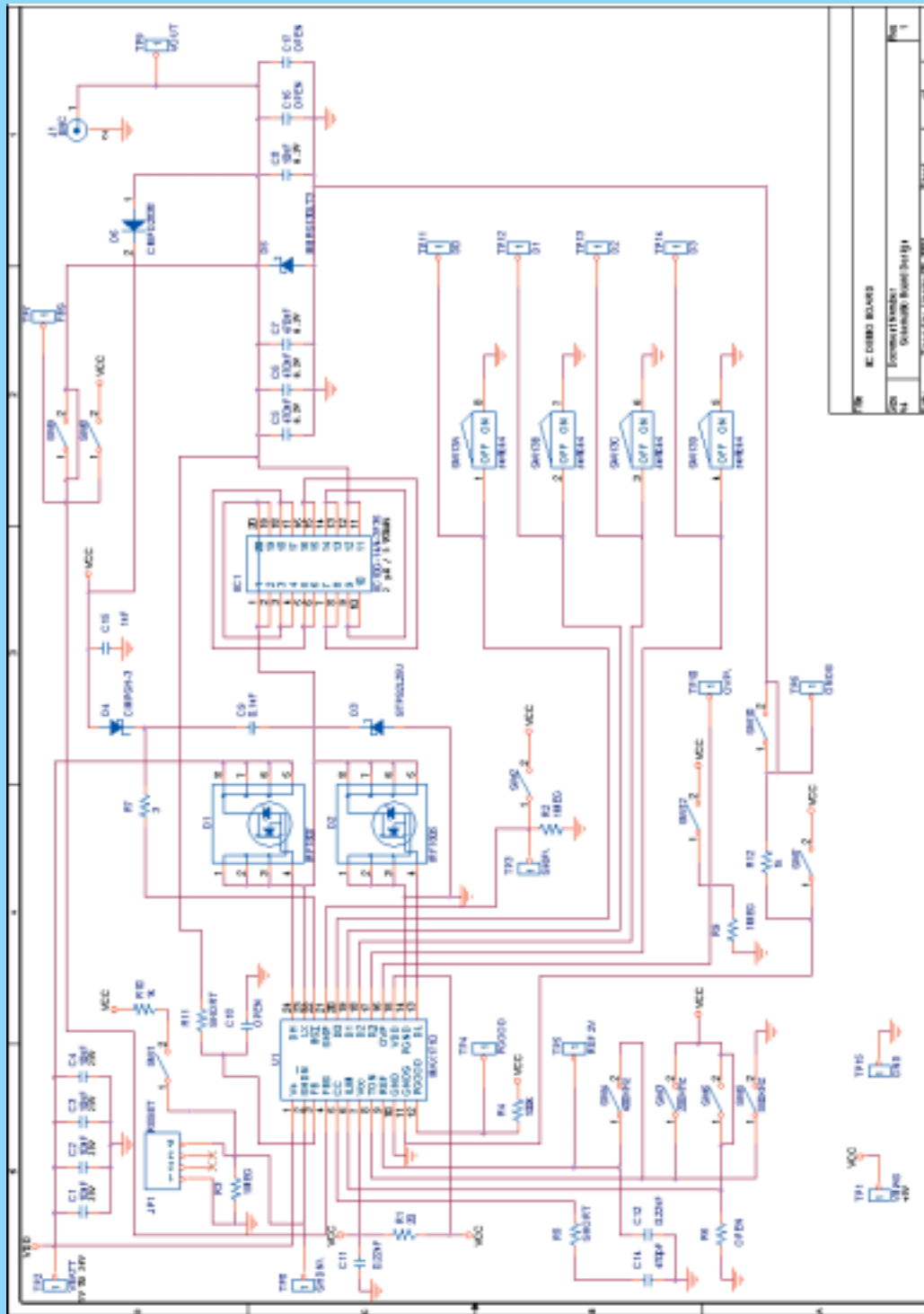

Fig. B1 Circuit diagram.

Annex B

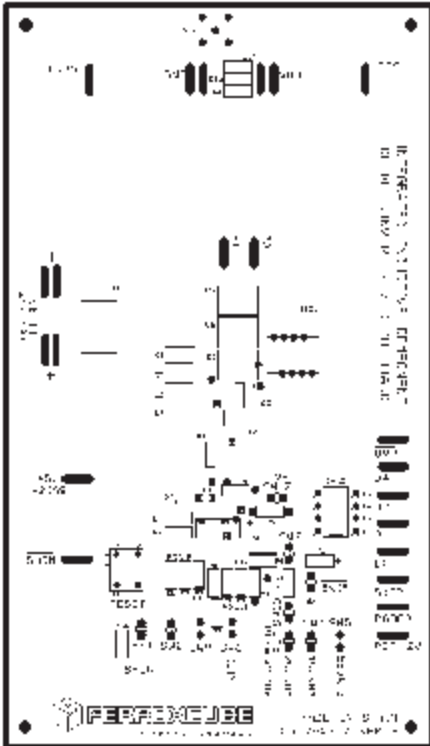

Fig. B2 Component placement - top side.

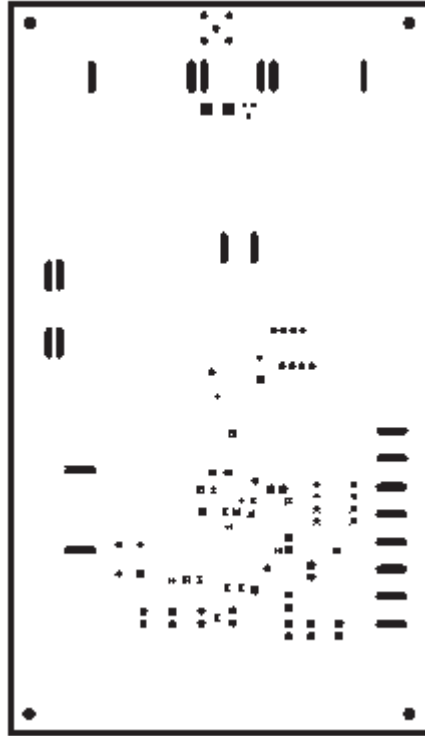

Fig. B3 Component placement - bottom side.

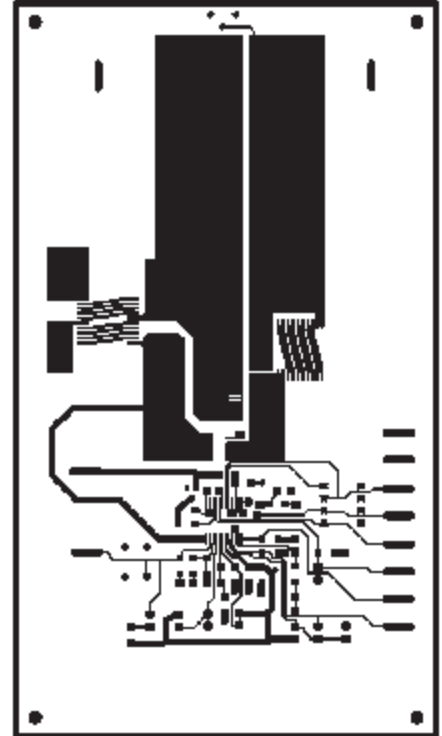

Fig. B4 PCB layout - top side.

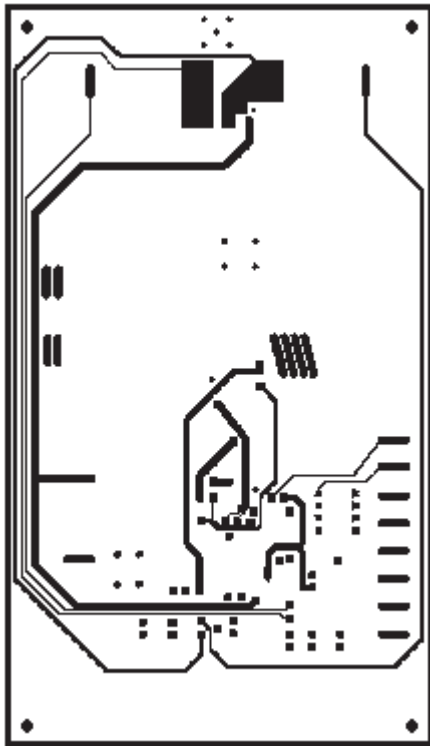

Fig. B5 PCB layout - bottom side.

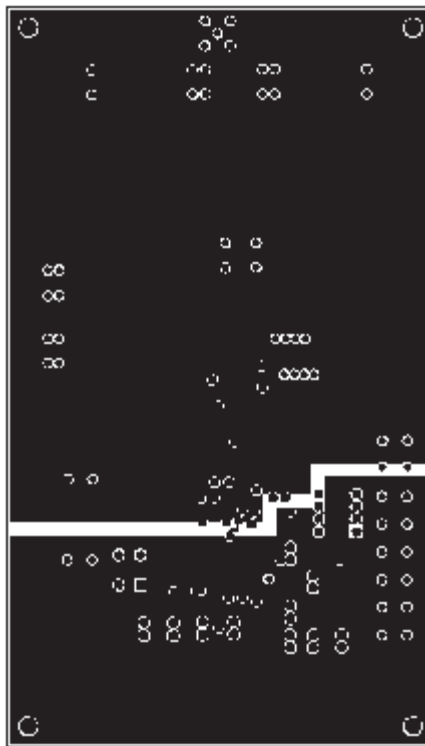

Fig. B6 PCB layout - GND layer

Annex B

Part reference	Part number	Description	Package	Manufacturer
C1, C2, C3, C4	18122R105K9BB0D	Ceramic capacitor: 1 μ F, 50V	1210	Phycomp
C5, C6, C7	T510X477K006AS	Low ESR tantalum capacitor: 470 μ F, 6V	2220	Kemet
C8	12062R106K7BB0D	Ceramic capacitor: 10 μ F, 10V	1210	Phycomp
C9	12062R104K9BB0D	Ceramic capacitor: 0.1 μ F, 50V	1206	Phycomp
C11, C12	12062R224K9BB0D	Ceramic capacitor: 0.22 μ F, 50V	1206	Phycomp
C14	12062R471K9BB0D	Ceramic capacitor: 470pF, 50V	1206	Phycomp
C15	12062R105K7BB0D	Ceramic capacitor: 1 μ F, 16V	1206	Phycomp
D1	IRF7807	N channel MOSFET	SO8	International Rectifier
D2	IRF7805	N channel MOSFET	SO8	International Rectifier
D3	STPS340U	3A Schottky Diode	SMB	SGS-Thomson
D4	BAT64	120mA Schottky Diode	SOT23	Infineon
D5	MBR5130LT3	1A Schottky Diode	403A-03	Motorola
D6	BAV70	Switching Diode	SOT23	Infineon
L1	IIC10G-14/4-3F35	2 μ H, 8A	IIC10	Ferroxcube
L2	IIC10-14/4-3E6	Common Mode Choke	IIC10	Ferroxcube
JP1		Horizontal Short Actuator		RS-Components
R1	RC1206JR-0720R	20 Ω , 5% resistor	1206	Phycomp
R2, R3, R9	RC1206JR-071M	1M Ω , 5% resistor	1206	Phycomp
R4	RC1206JR-07100K	100k Ω , 5% resistor	1206	Phycomp
R7	RC1206JR-073R	3 Ω , 5% resistor	1206	Phycomp
R10, R12	RC1206JR-071K	1k Ω , 5% resistor	1206	Phycomp
U1	MAX1710EEG	Controller for dc-dc converters	24-QSOP	Maxim
SW1		JUMPER LINK (close)		RS-Components
SW2		JUMPER LINK (open)		RS-Components
SW13		SWITCH 4	DIP-8	RS-Components

Table B1 Component list



For information about our extensive range of ferrite products, please visit our web site at:
www.ferroxcube.com