



LPG05AF-25

LIGHT EMITTING DIODE

LED LAMP

DESCRIPTION

25 Degree 5mm Round LED Lamp in High Green Color with Water Clear Lens and Stopper. Dice Material: InGaN

APPLICATION

- * Advertising Signs
- * Indicators
- * Traffic
- * Automotive Lighting

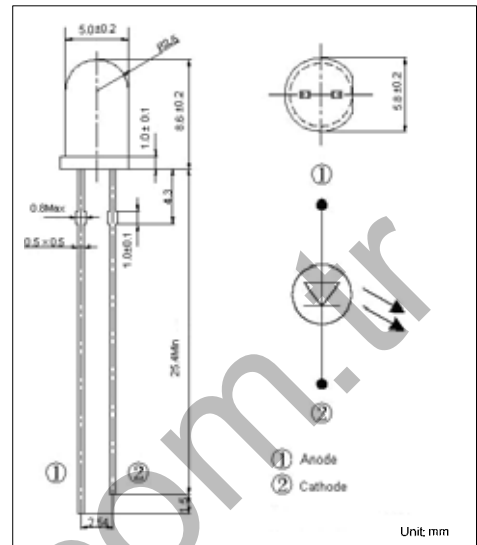

ORDERING INFORMATION

Ordering Number
LPG05AF-25

L P G 0 5 A F - 2 5	(1)View Angle	(1) 25: 25°±3°
	(2)Package Outline	(2) F: Round with Brim
	(3)Encapsulate Type	(3) A: Colorless Transparent
	(4)Diameter of Lamp	(4) 05: Φ5
	(5)Color Type	(5) PG: Pure Green
	(6)Product Type	(6) L: Lamp

■ ABSOLUTE MAXIMUM RATINGS (Ta=25)

PARAMETER	SYMBOL	RATINGS	UNIT
Forward Current	I_F	20	mA
Peak Forward Current	I_{fp}	80	mA
Power Dissipation	P_D	100	mW
Reverse Voltage	V_r	5	V
Lead Soldering Temperature	T_{sol}	MAX 260 for 3sec max (3mm from the base of the epoxy bulb)	
Electrostatic Discharge Classification	ESD	CLASS1	
Operating Temperature	T_{OPR}	-40 ~ +85	
Storage Temperature	T_{STG}	-40 ~ +100	

Note: Absolute maximum ratings are those values beyond which the device could be permanently damaged. Absolute maximum ratings are stress ratings only and functional device operation is not implied.

■ ELECTRICAL OPTICAL CHARACTERISTICS

PARAMETER	SYMBOL	TEST CONDITIONS	MIN	TYP	MAX	UNIT
Dominant Wavelength	λ_d	$I_F=20mA$	520		530	nm
Luminous Intensity	IV	$I_F=20mA$	6000		12000	mcd
Viewing Angle	2 θ 1/2	$I_F=20mA$		25		deg
Forward Voltage	V_F	$I_F=20mA$	3.0		3.6	V
Reverse Current	I_R	$V_R=5V$	0		10	μA

■ TYPICAL ELECTRO-OPTICAL CHARACTERISTICS CURVES

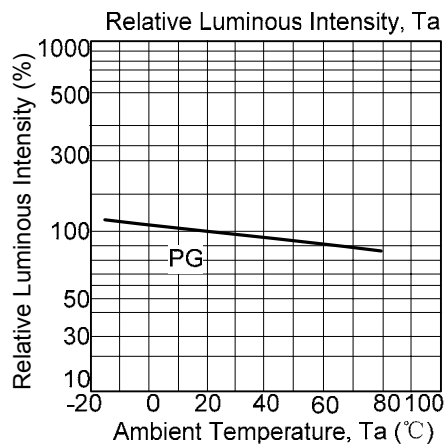
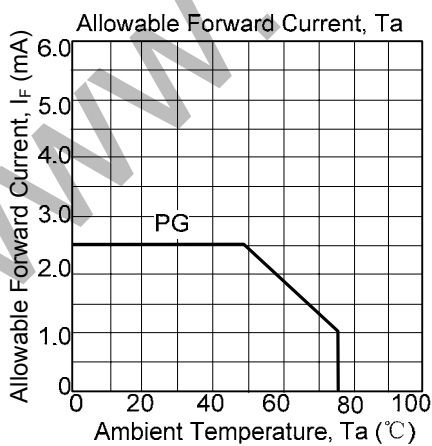
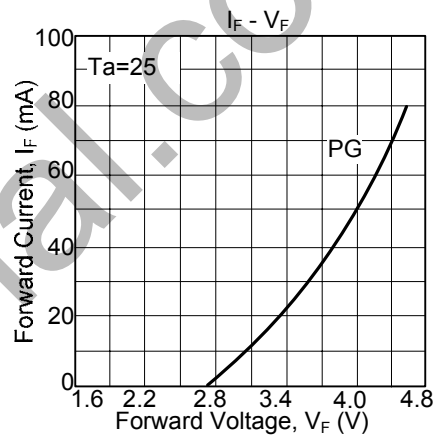
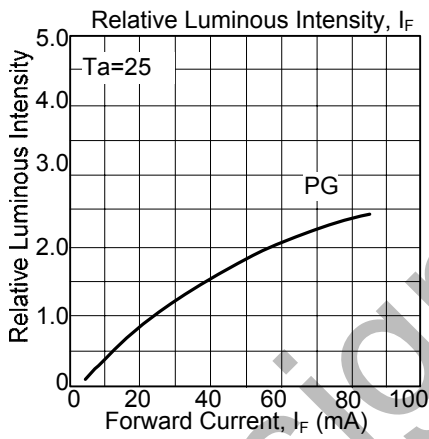
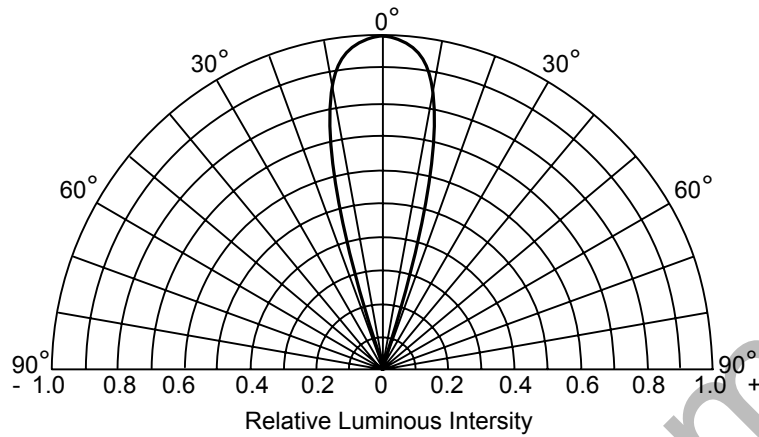

■ TYPICAL ELECTRO-OPTICAL CHARACTERISTICS CURVES

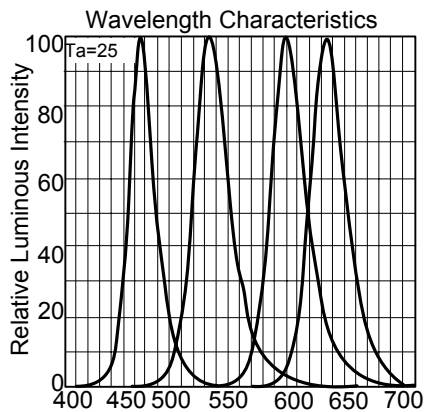

UTC assumes no responsibility for equipment failures that result from using products at values that exceed, even momentarily, rated values (such as maximum ratings, operating condition ranges, or other parameters) listed in products specifications of any and all UTC products described or contained herein. UTC products are not designed for use in life support appliances, devices or systems where malfunction of these products can be reasonably expected to result in personal injury. Reproduction in whole or in part is prohibited without the prior written consent of the copyright owner. The information presented in this document does not form part of any quotation or contract, is believed to be accurate and reliable and may be changed without notice.