



LYE05AF-25

LIGHT EMITTING DIODE

LED LAMP

DESCRIPTION

25 Degree 5mm Round LED Lamp in High Yellow Color with Water Clear Lens and Stopper
Dice Material: AlGaInP

APPLICATIONS

- * Advertising Signs
- * Indicators
- * Traffic
- * Automotive Lighting

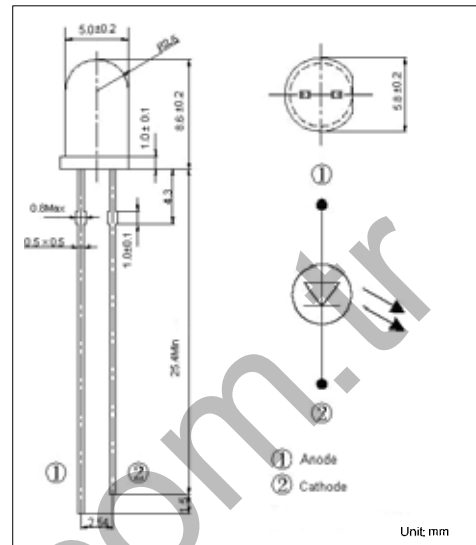

ORDERING INFORMATION

Ordering Number
LYE05AF-25

<p>L Y E 0 5 A F - 2 5</p> <p>(1)View Angle</p> <p>(2)Package Outline</p> <p>(3)Encapsulate Type</p> <p>(4)Diameter of Lamp</p> <p>(5)Color Type</p> <p>(6)Product Type</p>	<p>(1) 25: 25°±3°</p> <p>(2) F: Round with Brim</p> <p>(3) A: Colorless Transparent</p> <p>(4) 05: Φ5</p> <p>(5) YE: Yellow</p> <p>(6) L: Lamp</p>
---	--

■ ABSOLUTE MAXIMUM RATINGS (Ta=25)

PARAMETER	SYMBOL	RATINGS	UNIT
Reverse Voltage	V_R	5	V
Forward Current	I_F	20	mA
Peak Forward Current	I_{fp}	80	mA
Power Dissipation	P_D	100	mW
Operation Temperature	T_{OPR}	-40 ~ 85	
Storage Temperature	T_{STG}	-40 ~ 100	
Electrostatic Discharge Classification	ESD	CLASS1	

Note: Absolute maximum ratings are those values beyond which the device could be permanently damaged. Absolute maximum ratings are stress ratings only and functional device operation is not implied.

■ ELECTRICAL OPTICAL CHARACTERISTICS

PARAMETER	SYMBOL	TEST CONDITIONS	MIN	TYP	MAX	UNIT
Dominant Wavelength	λ_d	$I_F=20mA$	585		595	nm
Luminous Intensity	I_V	$I_F=20mA$	3500		7000	mcd
Viewing Angle	2 $\theta_{1/2}$	$I_F=20mA$		25		deg
Forward Voltage	V_F	$I_F=20mA$	1.7		2.4	V
Reverse Current	I_R	$V_R=5V$	0		10	μA

■ TYPICAL ELECTRO-OPTICAL CHARACTERISTICS CURVES

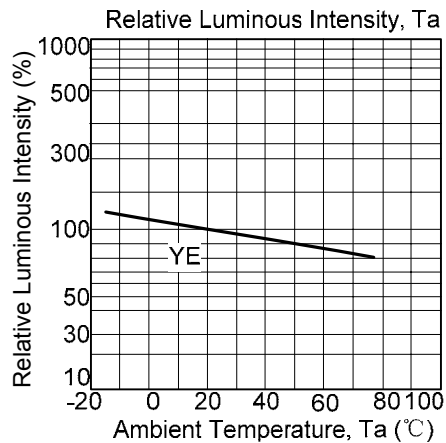
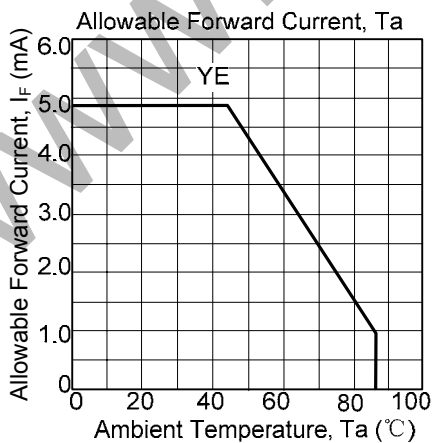
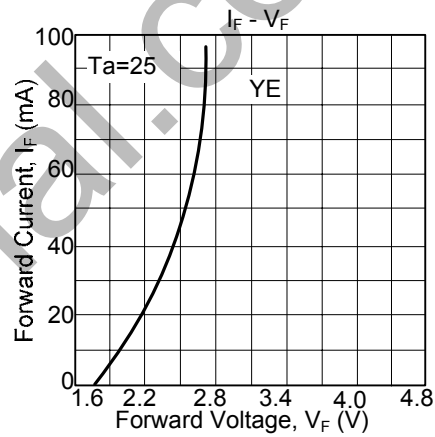
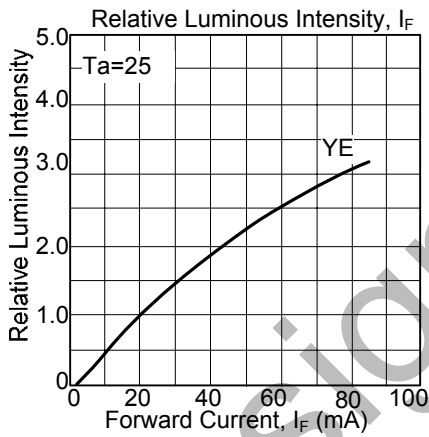
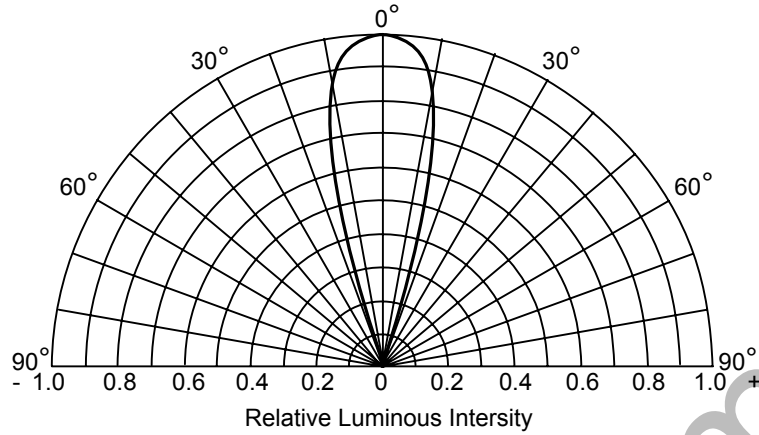

■ TYPICAL ELECTRO-OPTICAL CHARACTERISTICS CURVES

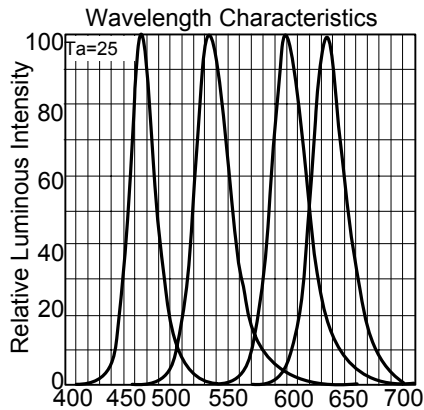

UTC assumes no responsibility for equipment failures that result from using products at values that exceed, even momentarily, rated values (such as maximum ratings, operating condition ranges, or other parameters) listed in products specifications of any and all UTC products described or contained herein. UTC products are not designed for use in life support appliances, devices or systems where malfunction of these products can be reasonably expected to result in personal injury. Reproduction in whole or in part is prohibited without the prior written consent of the copyright owner. The information presented in this document does not form part of any quotation or contract, is believed to be accurate and reliable and may be changed without notice.