



**Opto Plus LED Corp.**  
**0.39" SMD Type LED Display**  
**OPS-D3910LB-GW**  
**OPS-D3911LB-GW**

● **FEATURES**

- 0.39 inch (10.0 mm) Digit Height.
- SMD type.
- Low current operation.
- Gray face, White segment.
- RoHS compliant, Pb Free.

● **DESCRIPTION**

The OPS-D3910LB-GW & OPS-D3911LB-GW are 0.39 inch (10.0mm) height Dual 7-segment displays.

This device utilizes Super Bright Blue LED chip which are made from InGaN On a transparent GaN, substrate.

The display has Gray face, White segment.

● **DEVICE**

PART NO	DESCRIPTION
OPS-D3910LB-GW	Common Anode
OPS-D3911LB-GW	Common Cathode

**RoHS Compliance**



**Pb free.**



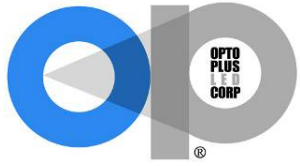

**Opto Plus LED Corp.**  
**0.39" SMD Type LED Display**  
**OPS-D3910LB-GW**  
**OPS-D3911LB-GW**

● **MECHANICAL DIMENSIONS**

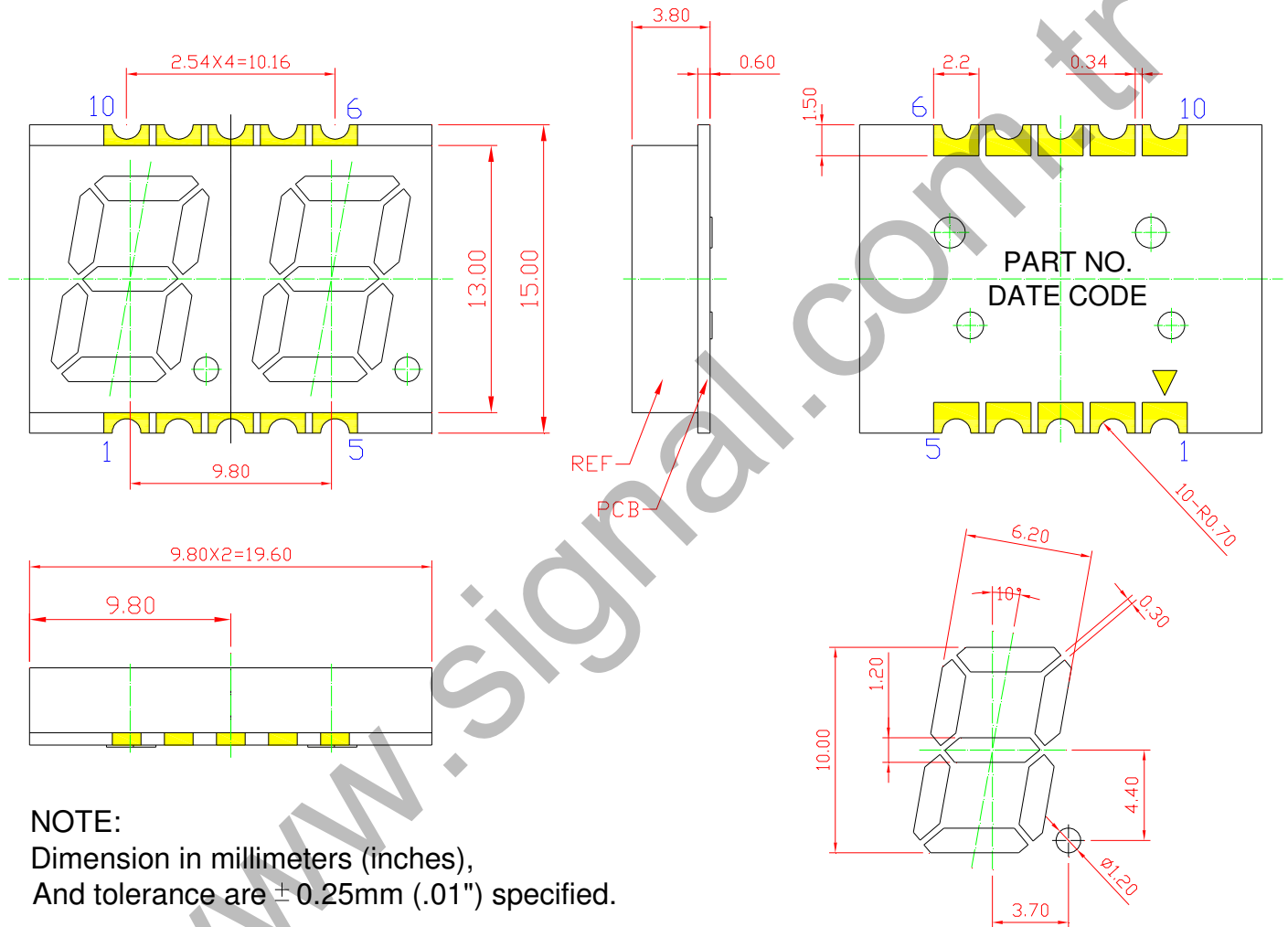

**NOTE:**  
 Dimension in millimeters (inches),  
 And tolerance are  $\pm 0.25\text{mm}$  (.01") specified.

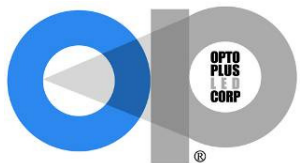

**Opto Plus LED Corp.**  
**0.39" SMD Type LED Display**  
**OPS-D3910LB-GW**  
**OPS-D3911LB-GW**

● **TYPICAL INTERNAL EQUIVALENT CIRCUIT**

Recommended  
Soldering Pattern

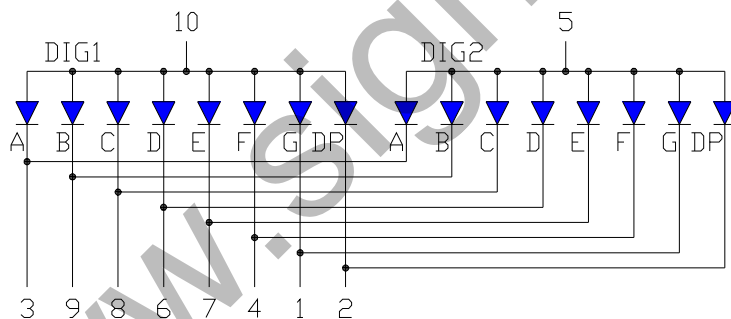
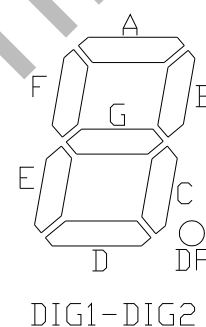
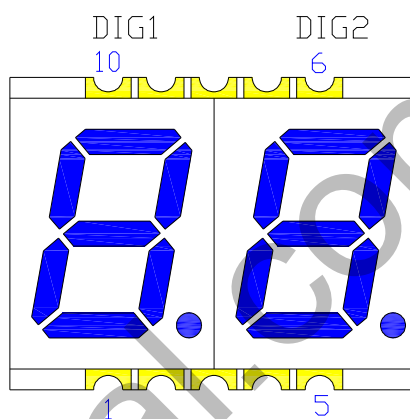
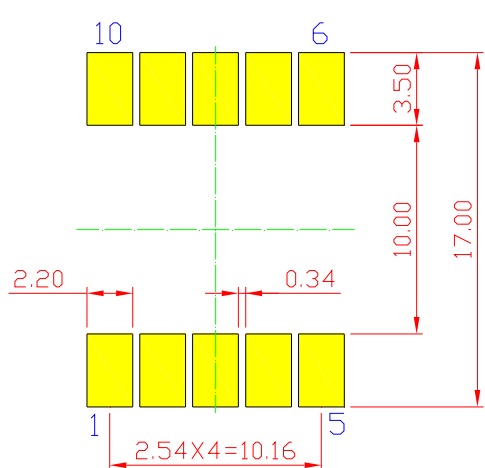

OPS-D3910LB-GW (Common Anode)

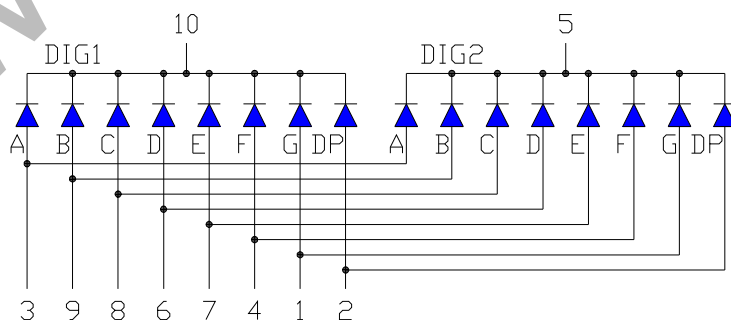

OPS-D3911LB-GW (Common Cathode)



**Opto Plus LED Corp.**  
**0.39'' SMD Type LED Display**  
**OPS-D3910LB-GW**  
**OPS-D3911LB-GW**

● **LB: SUPER BRIGHT BLUE (InGaN/GaN)**

ABSOLUTE MAXIMUM RATING AT Ta=25°C

Parameter	Symbol	Maximum Rating	Unit
Power dissipation	P <sub>AD</sub>	120	mW
Derating liner from 25°C	-	0.3	mA / °C
Continuous forward current	I <sub>AF</sub>	30	mA
Peak current (duty cycle 1/10, 1kHz)	I <sub>PF</sub>	100	mA
Reverse voltage	V <sub>R</sub>	5	V
Operating temperature	T <sub>OPR</sub>	-40 to +105	°C
Storage temperature	T <sub>STG</sub>	-40 to +105	°C

ELECTRICAL - OPTICAL CHARACTERISTICS AT Ta=25°C

Characteristic	Symbol	Condition	Min.	Type.	Max.	Unit
Forward Voltage, (Per Dice)	V <sub>F</sub>	I <sub>F</sub> =20mA	-	3.2	4.0	V
Reverse Current, (Per Dice)	I <sub>R</sub>	V <sub>R</sub> =8V	-	-	10	μA
Dominant Wavelength	λ <sub>D</sub>	I <sub>F</sub> =20mA	-	470	-	nm
Luminous Intensity	I <sub>v</sub>	I <sub>F</sub> =20mA	-	40	-	mcd
Spectral radiation bandwidth	Δλ	I <sub>F</sub> =20mA	-	30	-	nm

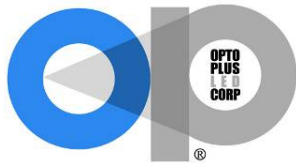

# Opto Plus LED Corp.

## 0.39" SMD Type LED Display

### OPS-D3910LB-GW

### OPS-D3911LB-GW

#### ● LB: SUPER BRIGHT BLUE (InGaN/GaN) CURVE

Typical Electro-optical Characteristic Curves  
(25 °C Free Air Temperature Unless Otherwise Specified)

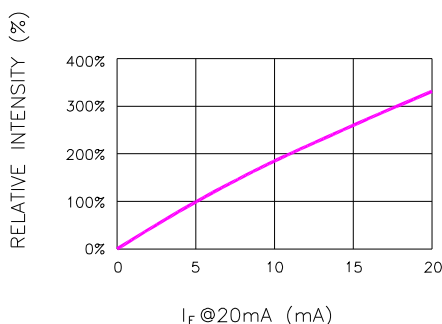

Fig.1 RELATIVE INTENSITY VS. FORWARD CURRENT

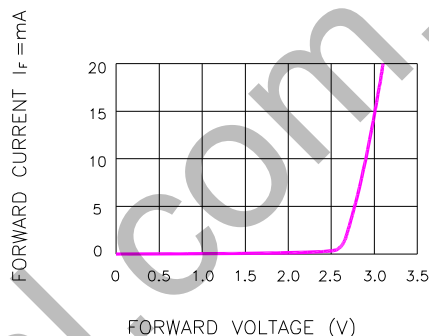

Fig.2 FORWARD CURRENT VS. FORWARD VOLTAGE

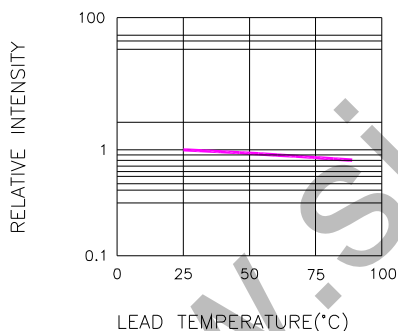

Fig.3 RELATIVE INTENSITY VS. LEAD TEMPERATURE  
(PULSED 20 mA; 300us PULSE, 10ms PERIOD)

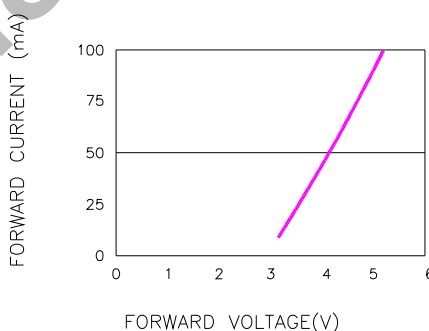

Fig.4 PEAK FORWARD VOLTAGE VS. FORWARD (100us TEST PULSE, 1% DUTY CYCLE)

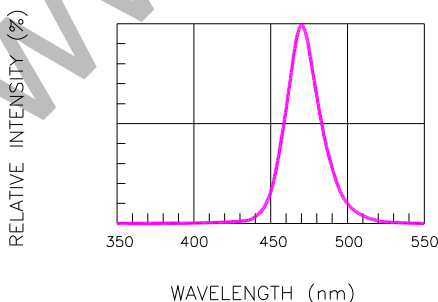

Fig.5 RELATIVE INTENSITY VS. WAVELENGTH

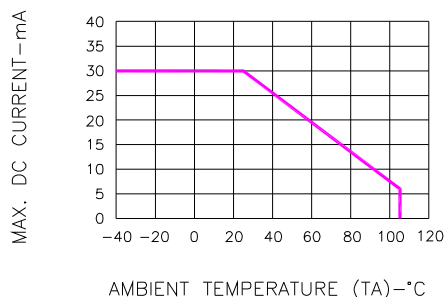
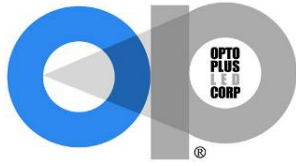

Fig.6 MAX. ALLOWABLE DC CURRENT VS. AMBIENT TEMPERATURE



**Opto Plus LED Corp.**  
**0.39" SMD Type LED Display**  
**OPS-D3910LB-GW**  
**OPS-D3911LB-GW**

● **RECOMMEND SOLDERING PROFILE**

SMT Soldering Profile

Pb free reflow soldering Profile

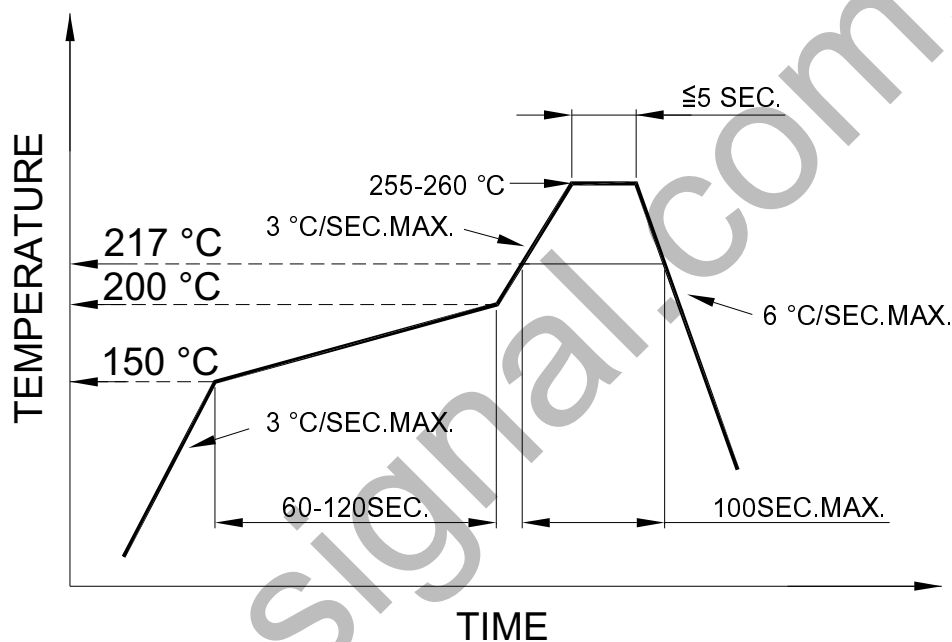

● **SOLDERING IRON**

Basic specification :  $\leq 4$  seconds when 260°C, If temperature is higher, time should be shorter (+10°C→1 sec). Power dissipation of iron should be smaller than 15W, and temperature should be controllable. Surface temperature of the device should be under 230°C.

● **REWORK**

Customer must finish rework within  $\leq 3$  sec under 350°C.