



CONNECTORS MANUFACTURER

Pin Header 2.0mm Stack R/A / Straight / Stack Straight / R/A Type

Specifications
 Current Rate: 2 AMP
 Insulation Resistance: 1000MΩ Min.
 Contact Resistance: 20mΩ Max.
 Dielectric Voltage: 500V AC for one minute
 Operation Temperature: -40°C to +105°C

Material
 Insulator: P.B.T or Hi-Temp. Thermoplastic, UL 94V-0
 Terminal: Copper Alloy
 Plating: Gold Plated

ORDER INFORMATION

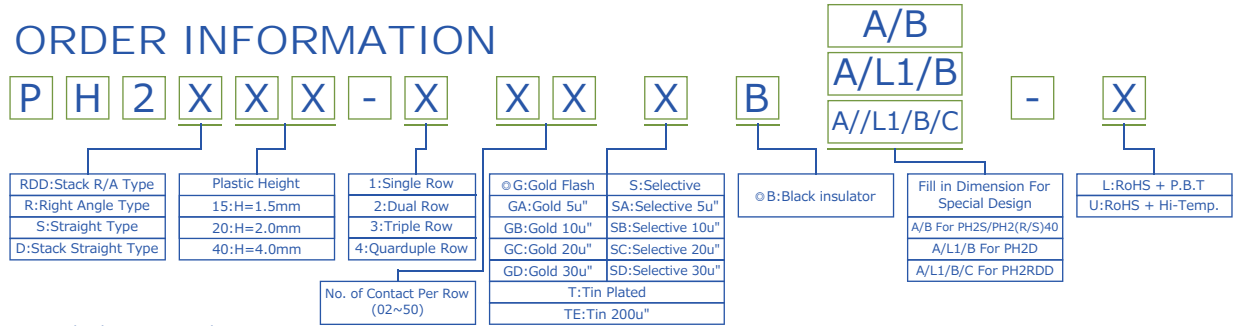

⊙: Standard Recommend

Pin Header 2.0mm 1 & 2 & 3 & 4 Row H=2.0mm Stack Right Angle Type

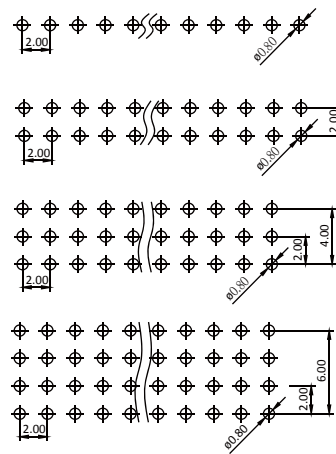
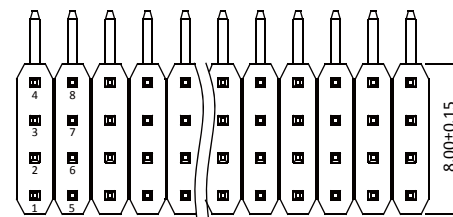
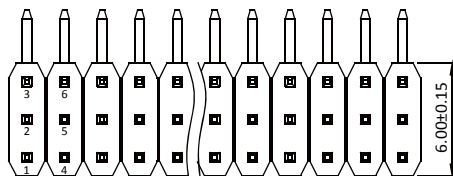
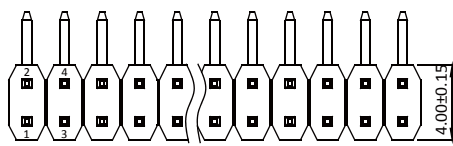
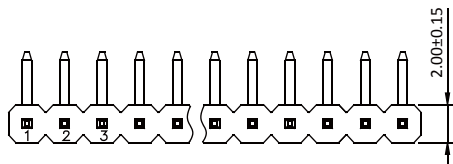

Recommended P.C.B. Layout (Top Side)
 (PCB BOARD TOLERANCE±0.05)

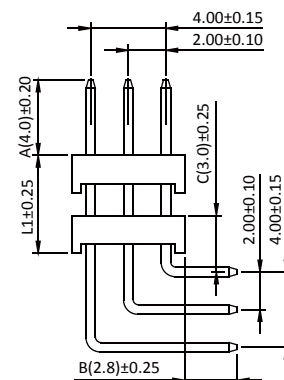
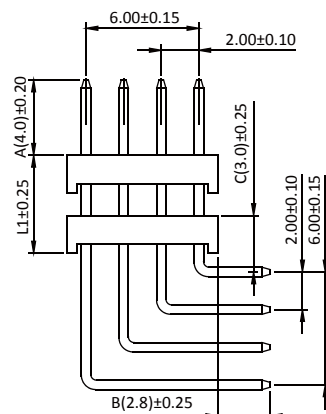
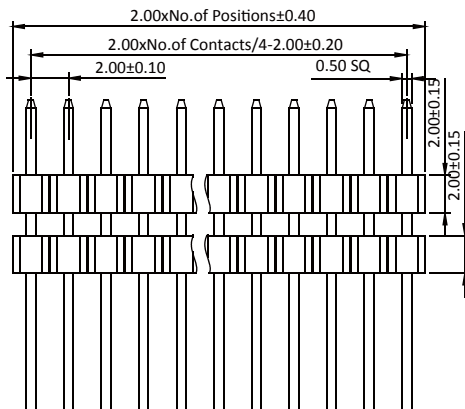
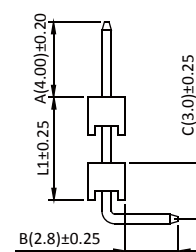
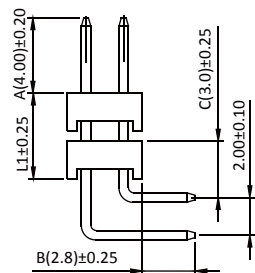
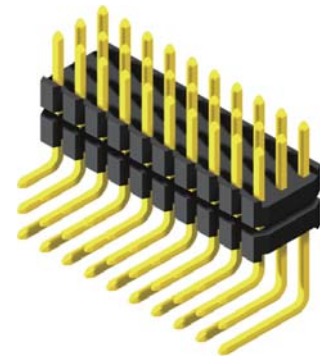

Part No.: PH2RDD-1/2/3/4XX-L/U

Pin Header 2.0mm

ROHS