

## Pin Header 1.0mm 1 & 2 Row H=1.0/1.5mm Right Angle Type

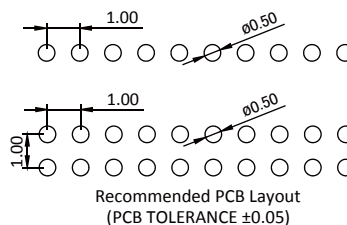

Part No.:PH5R10/15-1/2XX-U

## Pin Header 1.0mm 1 & 2 Row H=1.0/1.5mm Straight / Stack Straight Type

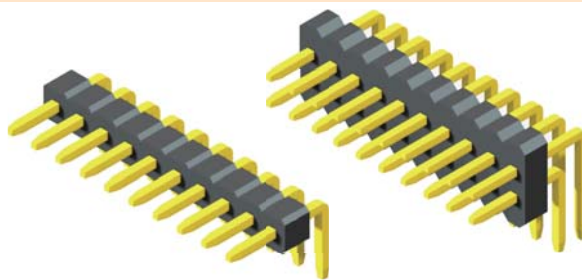
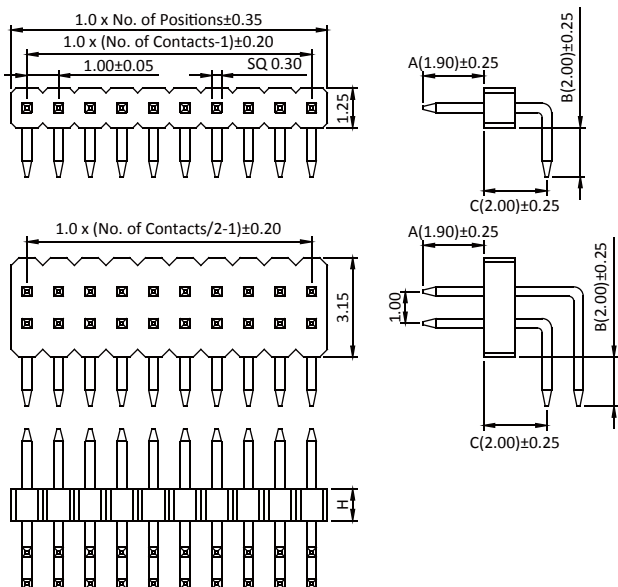
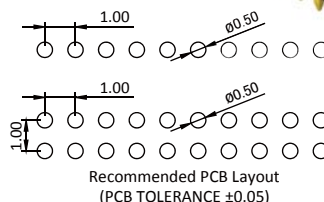
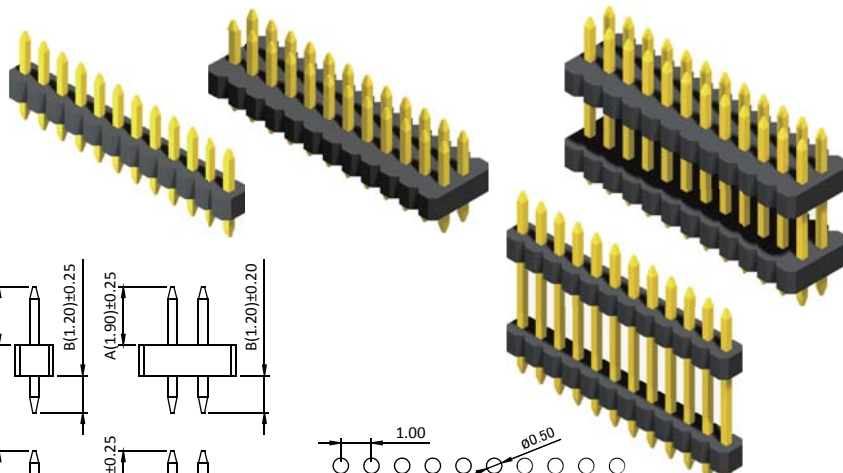
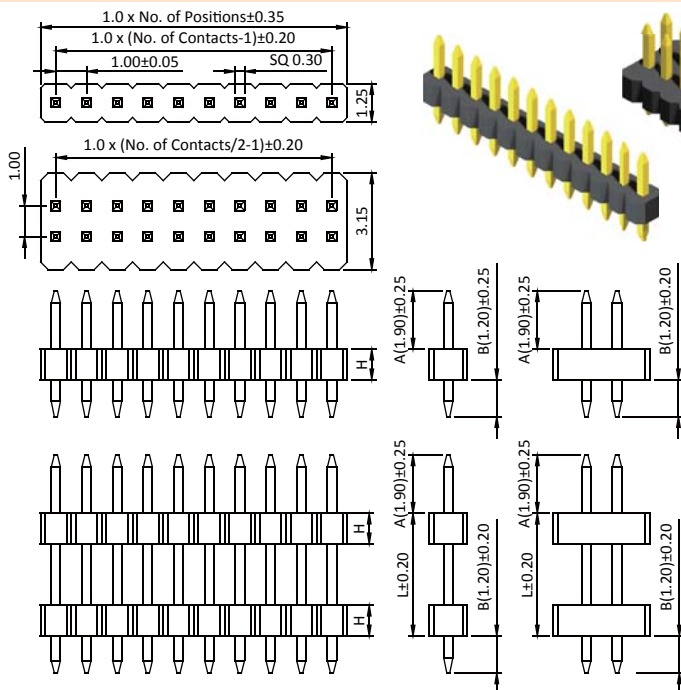

Part No.:PH5S10/15-1/2XX-U

PH5D10/15-1/2XX-U

## Pin Header 1.0mm 1 Row H=3.7mm SMT R/A Type

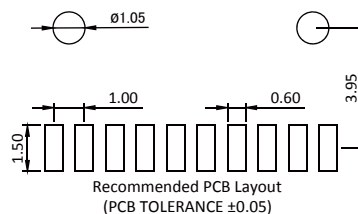
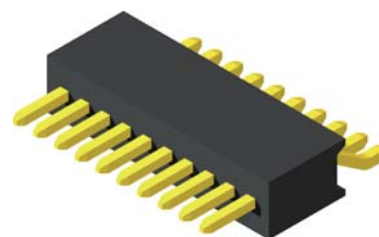
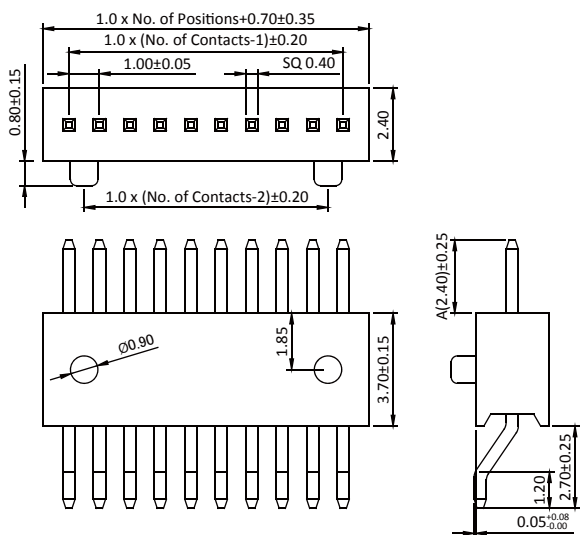

Part No.:PH5MR37-1XX-U