



# CONNECTORS MANUFACTURER

## S.ATA Conn. Series

### Specifications

- Current Rate: 1.5 AMP
- Insulation Resistance: 1000MΩ Max
- Contact Resistance: 30 mΩ Min
- Dielectric Voltage: 500V AC for one minute
- Operation Temperature: -55° C to +125° C
- Material
- Insulator: Polyester, UL 94V-0
- ©Standard: LCP
- Terminal: Brass
- Plating: Selective Plating

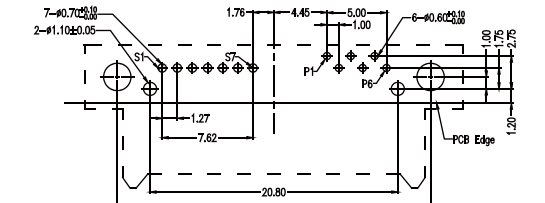
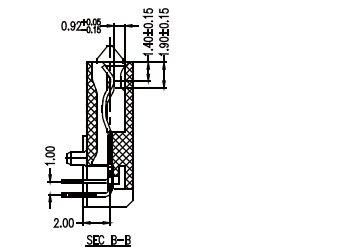
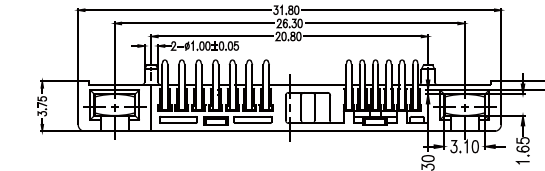
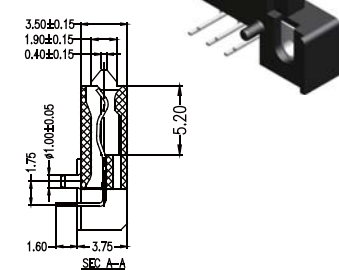
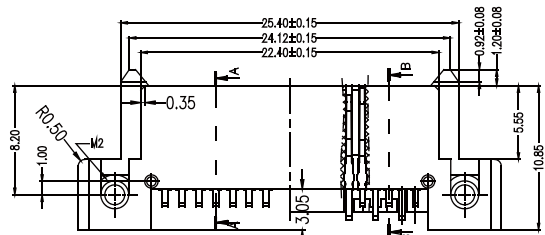
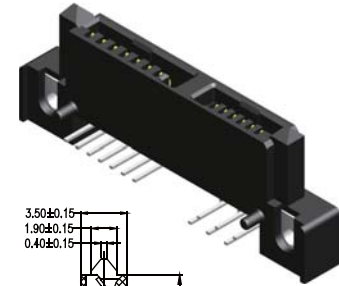
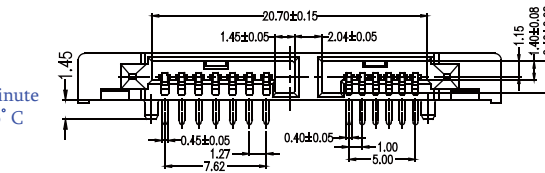

Recommended PCB Layout  
(PCB TOLERANCE ±0.05)

Part No.: SATAR-F13SB-G2-U

Pin Number	Signal Name
S1	GND
S2	A+
S3	A-
S4	GND
S5	B-
S6	B+
S7	GND

Pin Number	Power Line Designation
P1	DP
P2	+5V
P3	+5V
P4	MD
P5	GND
P6	GND

### Specifications

- Current Rate: 1.5 AMP
- Insulation Resistance: 1000MΩ Max
- Contact Resistance: 30 mΩ Min
- Dielectric Voltage: 500V AC for one minute
- Operation Temperature: -55° C to +125° C
- Material
- Insulator: Polyester, UL 94V-0
- ©Standard: LCP
- Terminal: Brass
- Plating: Selective Plating

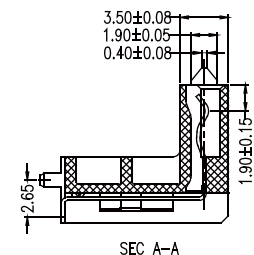
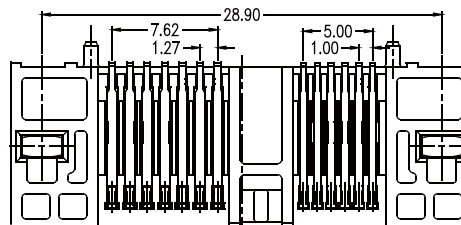
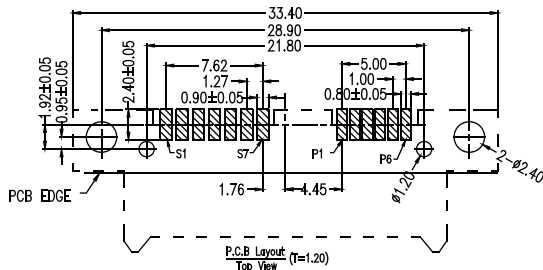
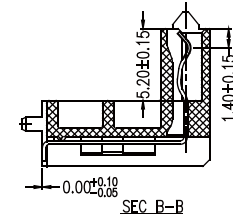
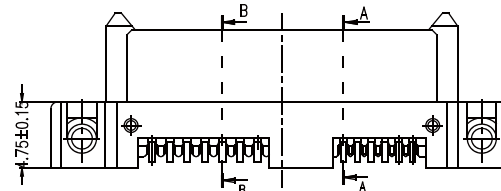
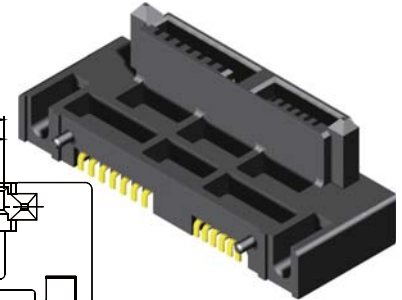
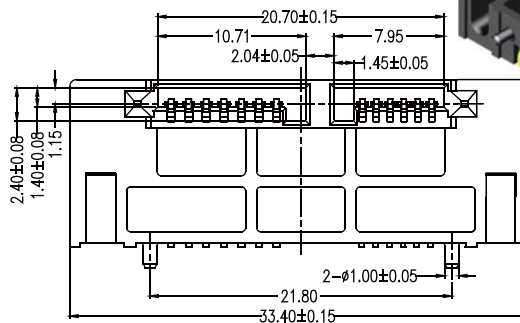

Part No.: SATAM-F13SB-G6-U

Serial ATA

Pb

ROHS