

Core **Toroid 13/7.1/4.8**

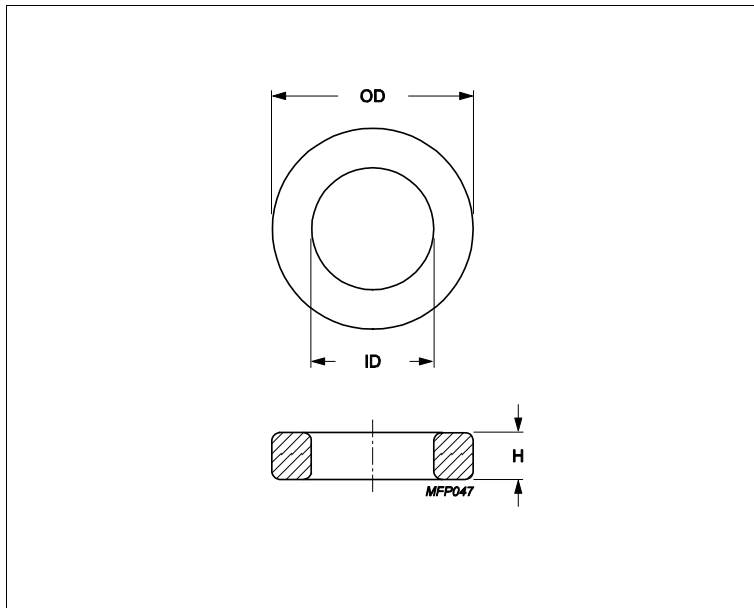

Effective parameters			
	Parameter	Value	Unit
$\Sigma(I/A)$	core factor (C1)	2.4	mm ⁻¹
Ve	effective volume	361	mm ³
Le	effective length	29.5	mm
Ae	effective area	12.3	mm ²
m	mass of core	≈ 1.8	g/pcs

Epoxy coating DC isolation voltage 1500.

Maximum operating temperature of the coating is 200°C.

Dimensions (mm)

Cores	OD	ID	H	
TX13/7.1/4.8	13.35 max	6.55 min	5.33 max	Epoxy Coated

Core data

Cores	Material	AI (nH/turns ²)	AI tolerance	$\mu\epsilon$
TX13/7.1/4.8	3C94	1280	± 25%	≈ 2300
TX13/7.1/4.8	3E10	5560	± 20%	≈ 10000
TX13/7.1/4.8	3E12	6670	± 30%	≈ 12000
TX13/7.1/4.8	3E27	3060	± 25%	≈ 5500
TX13/7.1/4.8	3E6 (3E10-M)	5560	± 30%	≈ 10000
TX13/7.1/4.8	3E65	2890	± 25%	≈ 5200