



AP201607-ATC4

SMD Type Amber Emitter

Features

- Top view 2016 package
- Viewing Angle = $\pm 60^\circ$
- Compatible with infrared and vapor phase reflow solder process
- High reliability
- Ultra bright Amber
- RoHS compliance

Applications

- Optical indicator.
- Switch and Symbol Display.

Description

The AC201607-ATC4 is an AlGaInP Amber LED housed in a miniature SMD package. The device has a dominant wavelength of 605nm LED.

Package Outline

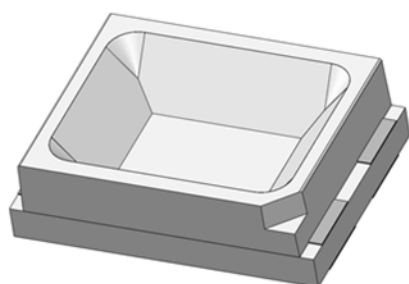

Cathode

Anode

Schematic

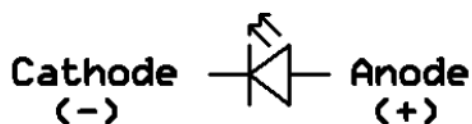



AP201607-ATC4

SMD Type Amber Emitter

Absolute Maximum Rating at 25°C

| Symbol | Parameters | Ratings | Units | Notes |
|------------------|--|------------|-------|-------|
| I _F | Continuous Forward Current | 25 | mA | |
| I _{FP} | Peak Forward Current | 80 | mA | 1 |
| V _R | Reverse Voltage | 5 | V | |
| T _{opr} | Operating Temperature | -40 ~ +85 | °C | |
| T _{stg} | Storage Temperature | -40 ~ +100 | °C | |
| T _{sol} | Soldering Temperature | 260 | °C | 2 |
| P _D | Power Dissipation at(or below) 25°C Free Air Temperature | 65 | mW | |

Electro-Optical Characteristics *TA = 25°C (unless otherwise specified)*

Optical Characteristics

| Symbol | Parameters | Test Conditions | Min | Typ | Max | Units | Notes |
|------------------|-------------------------|----------------------|-------|-----|-------|-------|-------|
| I _v | Luminous Intensity | I _F =20mA | 140 | - | 285 | mcd | 3 |
| λ _d | Dominant Wavelength | I _F =20mA | 600.5 | - | 609.5 | nm | 4 |
| θ _{1/2} | Angle of Half Intensity | I _F =20mA | - | ±60 | - | deg | |

Electrical Characteristics

| Symbol | Parameters | Test Conditions | Min | Typ | Max | Units | Notes |
|----------------|-----------------|----------------------|------|-----|------|-------|-------|
| V _F | Forward Voltage | I _F =20mA | 1.75 | - | 2.35 | V | 5 |
| I _R | Reverse Current | V _R =5V | - | - | 10 | μA | |

Notes:

1. I_{FP} Conditions--Pulse Width ≤ 100μs and Duty ≤ 10%.
2. Soldering time ≤ 10 seconds.
3. Bin Range of Luminous Intensity

| Bin Code | Min | Max | Unit | Condition |
|----------|-----|-----|------|----------------------|
| R2 | 140 | 180 | mcd | I _F =20mA |
| S1 | 180 | 225 | | |
| S2 | 225 | 285 | | |

Tolerance of Luminous Intensity ±10%



AP201607-ATC4

SMD Type Amber Emitter

4. Bin Range of Dominant Wavelength

| Bin Code | Min | Max | Unit | Condition |
|----------|-------|-------|------|-------------------|
| S8 | 600.5 | 603.5 | nm | $I_F=20\text{mA}$ |
| S9 | 603.5 | 606.5 | | |
| S10 | 606.5 | 609.5 | | |

Tolerance of Dominant Wavelength: $\pm 1\text{nm}$.

5. Bin Range of Forward Voltage

| Bin Code | Min | Max | Unit | Condition |
|----------|------|------|------|-------------------|
| 0 | 1.75 | 1.95 | V | $I_F=20\text{mA}$ |
| 1 | 1.95 | 2.15 | | |
| 2 | 2.15 | 2.35 | | |

Tolerance of Forward Voltage $\pm 0.1\text{V}$.



Typical Characteristic Curves

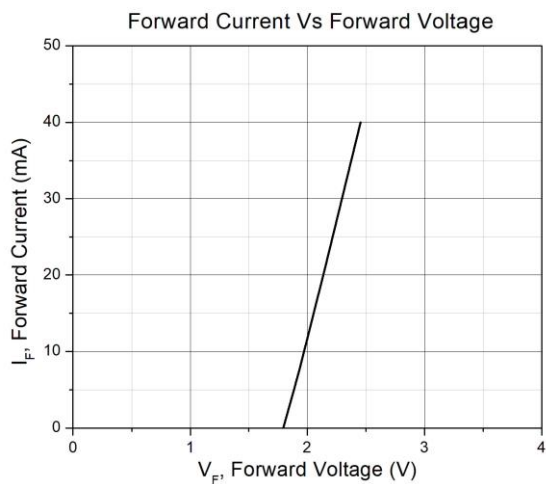

Figure 1

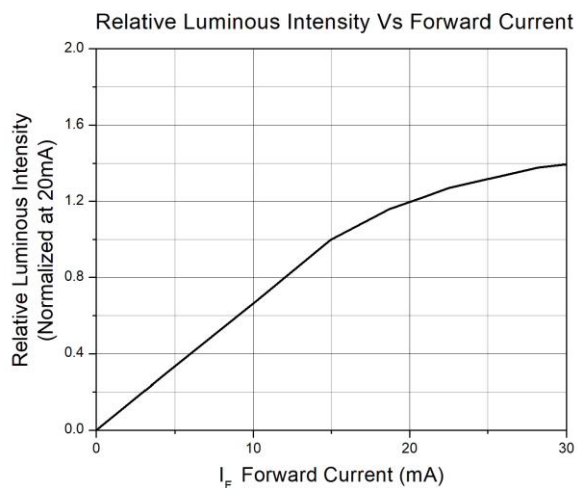

Figure 2

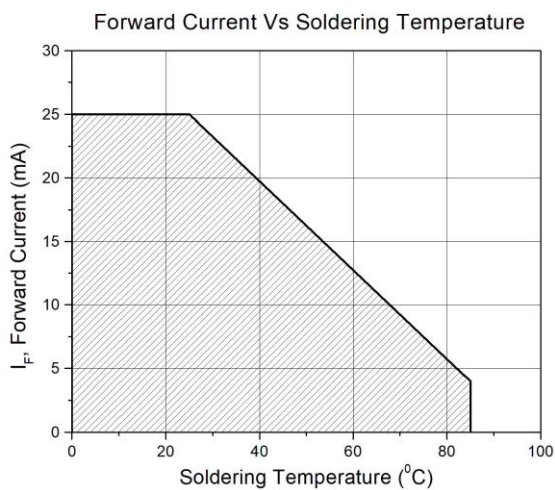

Figure 3

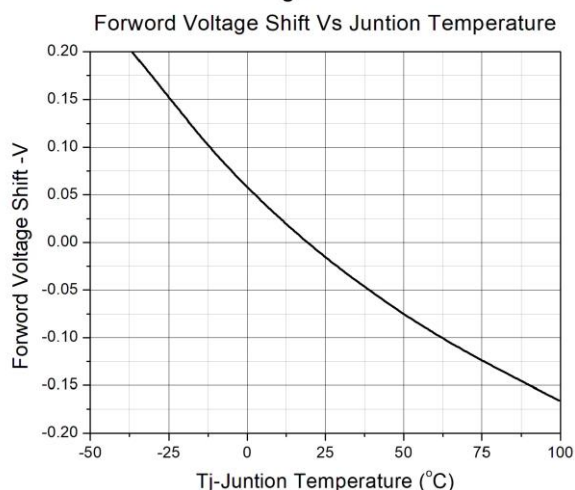

Figure 4

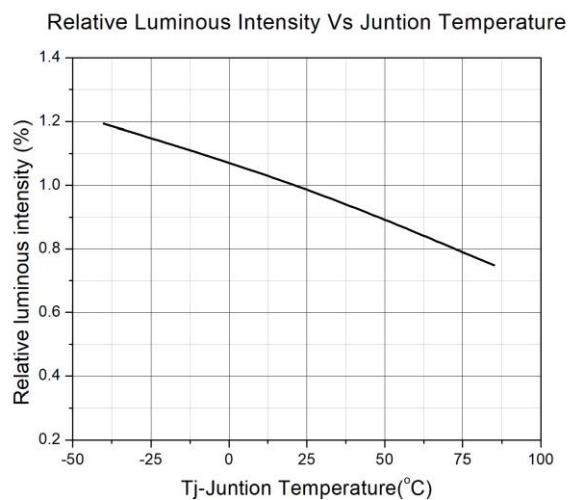

Figure 5

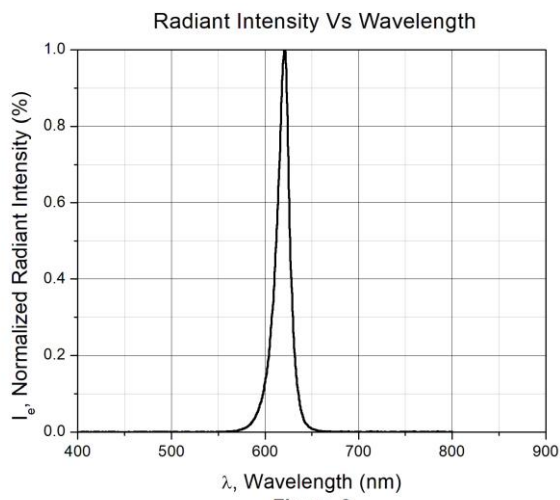

Figure 6



Typical Characteristic Curves

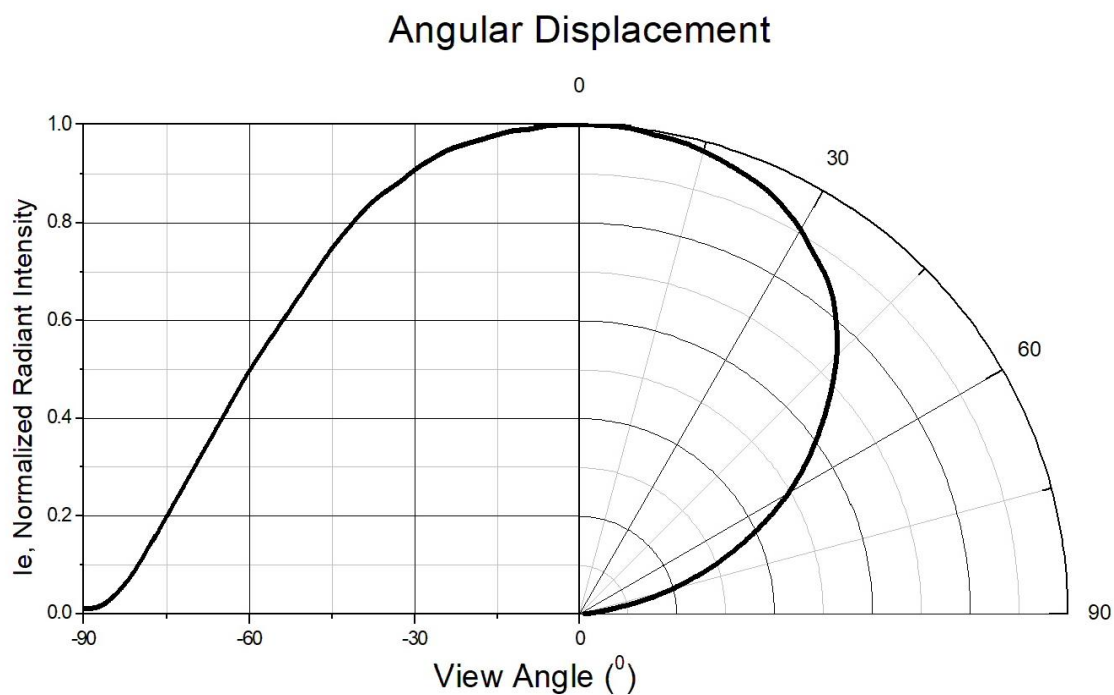

Figure 7



AP201607-ATC4

SMD Type Amber Emitter

Package Dimension *All dimensions are in mm, unless otherwise stated*

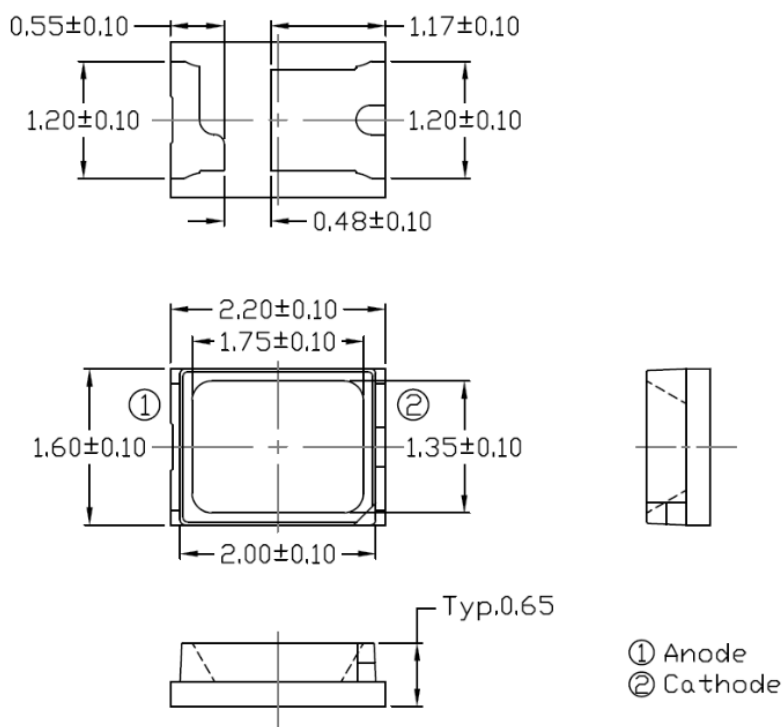

Note: Tolerance unless mentioned is ±0.1mm.

Recommended Soldering Mask *All dimensions are in mm, unless otherwise stated*

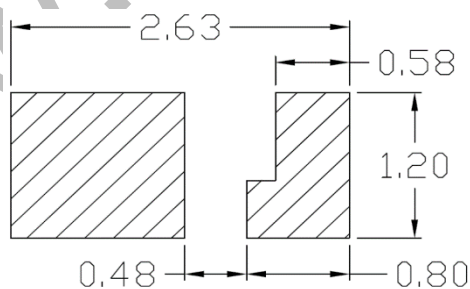

Note: Tolerance unless mentioned is ±0.1mm.

Ordering Information

| Part Number | Description | Quantity |
|---------------|-------------|----------|
| AC201607-ATC4 | Tape & Reel | 4000 pcs |



AP201607-ATC4

SMD Type Amber Emitter

Reel Dimension *All dimensions are in mm, unless otherwise stated*

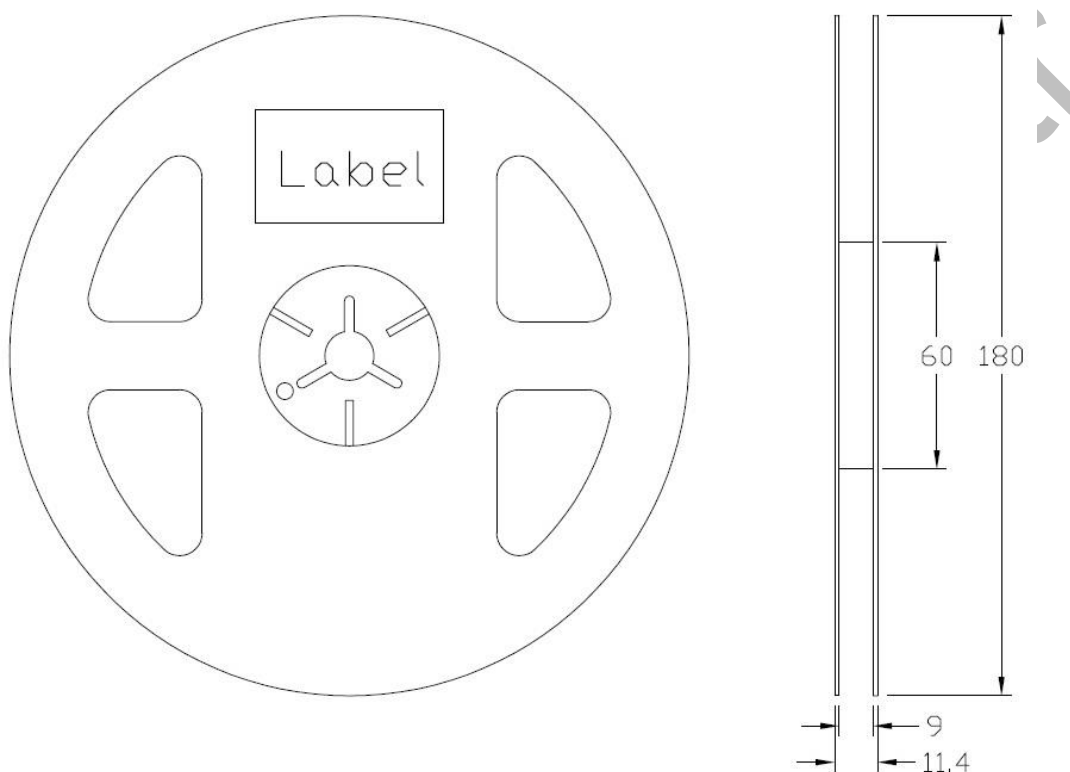

Tape Dimension *All dimensions are in mm, unless otherwise stated*

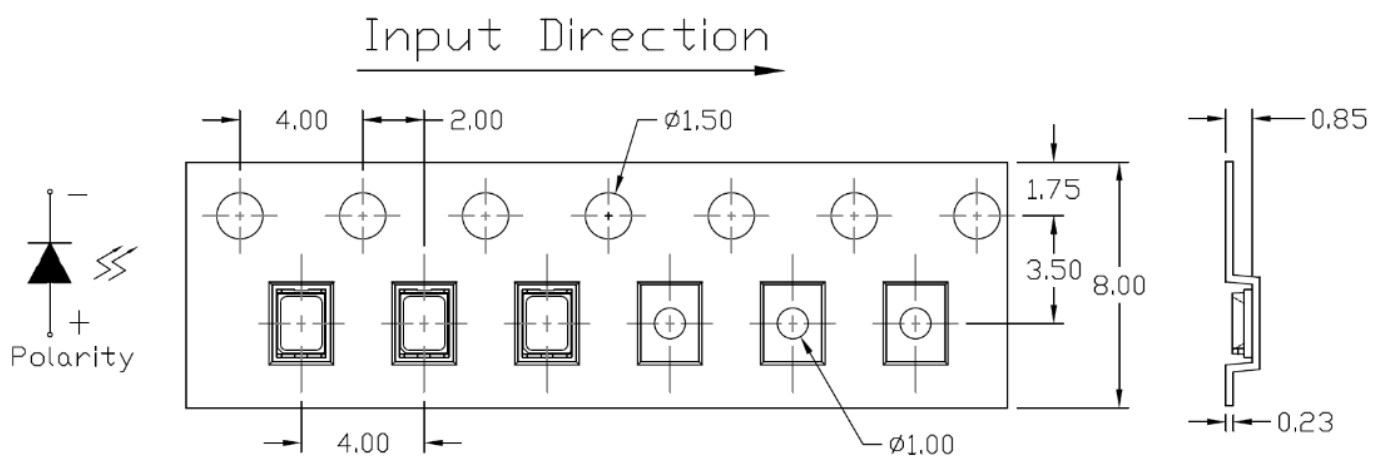

Note: Tolerance unless mentioned is ± 0.1 mm.



Label Form Specification



CPN : Customer Part Number
 Part no: CTM Production Number
 Serial no: Production Number
 Lot no: Lot number
 Q'ty: Packing Quantity
 Date Code: Manufacture Date
 IV : Bin Code of Luminous Intensity
 WD : Bin Code of Dominant Wavelength
 VF : Bin Code of Forward Voltage
 MADE IN CHINA: Production Place

Storage Condition

1. Do not open moisture proof bag before the products are ready to use.
2. The moisture barrier bag should be stored at 30°C and 90%R.H. max. before opening.
Shelf life of non-opened bag is 12 months after the bag sealing date.
3. After opening the moisture barrier bag floor life is 168h at 30°C/60%RH. max. Unused LEDs should be resealed into moisture barrier bag. (Refer to J-STD-020 Standard)
4. If the moisture absorbent material has faded away or the LEDs have exceeded the storage time, baking treatment should be performed using the J-STD-033 Standard conditions.



Reflow Profile

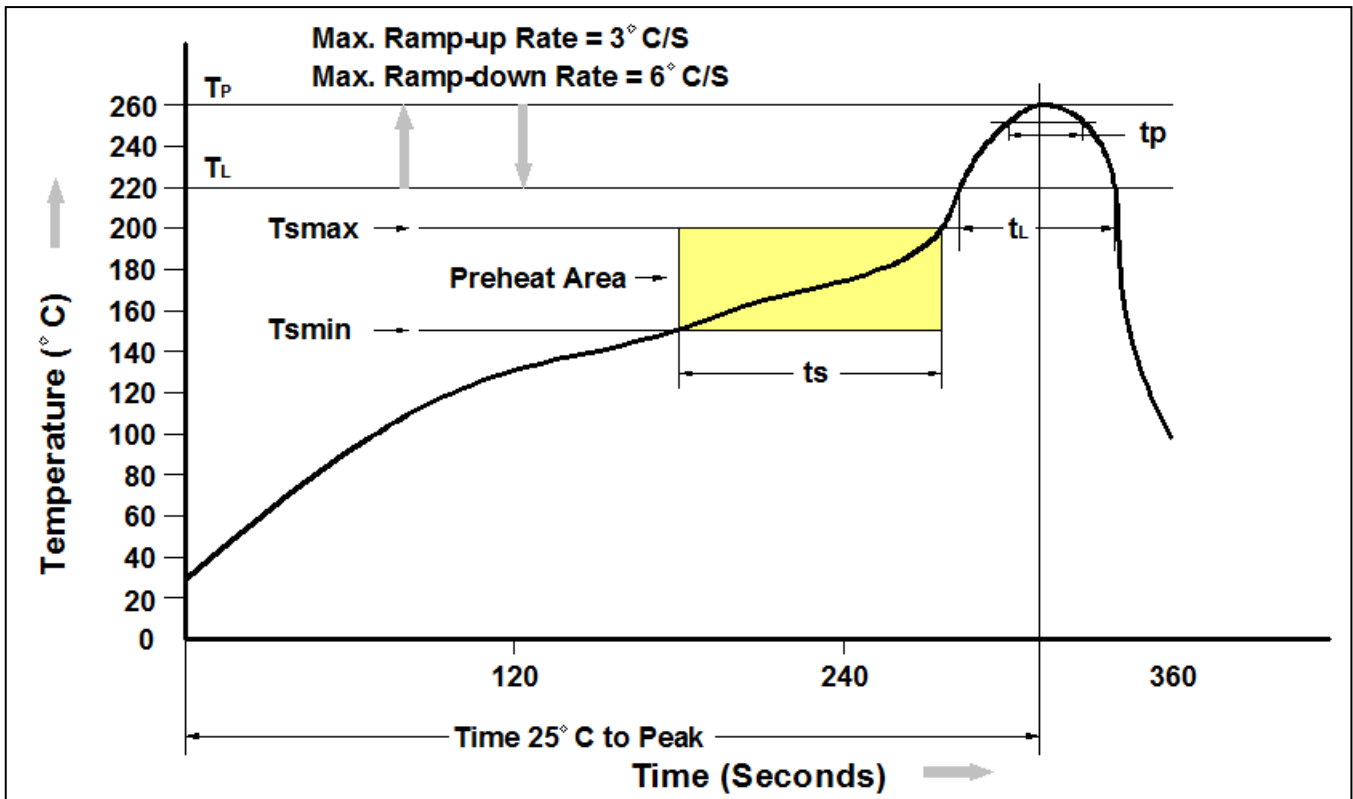

| Profile Feature | Pb-Free Assembly Profile |
|---|--------------------------|
| Temperature Min. (T _{sm}) | 150°C |
| Temperature Max. (T _{sm}) | 200°C |
| Time (t _s) from (T _{sm} to T _{sm}) | 60-120 seconds |
| Ramp-up Rate (t _l to t _p) | 3°C/second max. |
| Liquidous Temperature (T _l) | 217°C |
| Time (t _l) Maintained Above (T _l) | 60 – 150 seconds |
| Peak Body Package Temperature | 260°C +0°C / -5°C |
| Time (t _p) within 5°C of 260°C | 30 seconds |
| Ramp-down Rate (T _p to T _l) | 6°C/second max |
| Time 25°C to Peak Temperature | 8 minutes max. |



DISCLAIMER

CT MICRO RESERVES THE RIGHT TO MAKE CHANGES WITHOUT FURTHER NOTICE TO ANY PRODUCTS HEREIN TO IMPROVE RELIABILITY, FUNCTION OR DESIGN. CT MICRO DOES NOT ASSUME ANY LIABILITY ARISING OUT OF THE APPLICATION OR USE OF ANY PRODUCT OR CIRCUIT DESCRIBED HEREIN; NEITHER DOES IT CONVEY ANY LICENSE UNDER ITS PATENT RIGHTS, NOR THE RIGHTS OF OTHERS.

CT MICRO ARE NOT AUTHORIZED FOR USE AS CRITICAL COMPONENTS IN LIFE SUPPORT DEVICES OR SYSTEMS WITHOUT EXPRESS WRITTEN APPROVAL OF CT MICRO INTERNATIONAL CORPORATION.

- 1. Life support devices or systems are devices or systems which, (a) are intended for surgical implant into the body, or (b) support or sustain life, or (c) whose failure to perform when properly used in accordance with instruction for use provided in the labelling, can be reasonably expected to result in significant injury to the user.*
- 2. A critical component is any component of a life support device or system whose failure to perform can be reasonably expected to cause the failure of the life support device or system, or to affect its safety or effectiveness.*