



AP321015-ASC3

SMD Type Amber Emitter

Features

- Side view 1204 package
- Viewing Angle = $\pm 60^\circ$
- Compatible with infrared and vapor phase reflow solder process
- High reliability
- Ultra bright Amber
- RoHS compliance

Applications

- Optical indicator.
- Switch and Symbol Display.

Description

The AP321015-ASC3 is an AlGaInP Amber LED housed in a miniature SMD package. The device has a dominant wavelength of 605 nm LED.

Package Outline

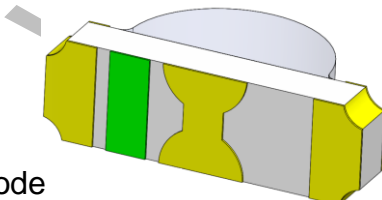
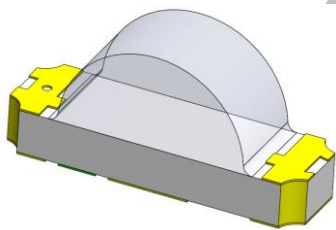

Cathode

Anode

Schematic

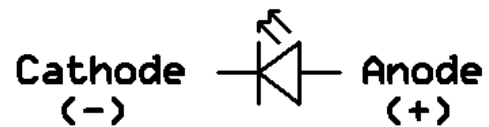



AP321015-ASC3

SMD Type Amber Emitter

Absolute Maximum Rating at 25°C

Symbol	Parameters	Ratings	Units	Notes
I _F	Continuous Forward Current	25	mA	
I _{FP}	Peak Forward Current	60	mA	1
V _R	Reverse Voltage	5	V	
T _{opr}	Operating Temperature	-40 ~ +85	°C	
T _{stg}	Storage Temperature	-40 ~ +100	°C	
T _{sol}	Soldering Temperature	260	°C	2
P _D	Power Dissipation at(or below) 25°C Free Air Temperature	65	mW	

Electro-Optical Characteristics *TA = 25°C (unless otherwise specified)*

Optical Characteristics

Symbol	Parameters	Test Conditions	Min	Typ	Max	Units	Notes
I _v	Luminous Intensity	I _F =20mA	89	-	250	mcd	3
λ _D	Dominant Wavelength	I _F =20mA	600	-	610	nm	4
θ _{1/2}	Angle of Half Intensity	I _F =20mA	-	±60	-	deg	

Electrical Characteristics

Symbol	Parameters	Test Conditions	Min	Typ	Max	Units	Notes
V _F	Forward Voltage	I _F =20mA	1.7	-	2.5	V	5
I _R	Reverse Current	V _R =5V	-	-	1	μA	

Notes:

1. I_{FP} Conditions--Pulse Width ≤ 100μs and Duty ≤ 10%.
2. Soldering time ≤ 10 seconds.
3. Bin Range of Luminous Intensity

Bin Code	Min	Max	Unit	Condition
n1	89	100	mcd	I _F =20mA
n2	100	130		
o1	130	160		
o2	160	200		
p1	200	250		

Tolerance of Luminous Intensity ±10%



AP321015-ASC3

SMD Type Amber Emitter

4. Bin Range of Dominant Wavelength

Bin Code	Min	Max	Unit	Condition
I1	600	605	nm	I _F =20mA
I2	605	610		

Tolerance of Dominant Wavelength: ± 1 nm.

5. Bin Range of Forward Voltage

Bin Code	Min	Max	Unit	Condition
V4	1.7	1.9	V	I _F =20mA
V5	1.9	2.1		
V6	2.1	2.3		
V7	2.3	2.5		

Tolerance of Forward Voltage ± 0.1 V.



Typical Characteristic Curves

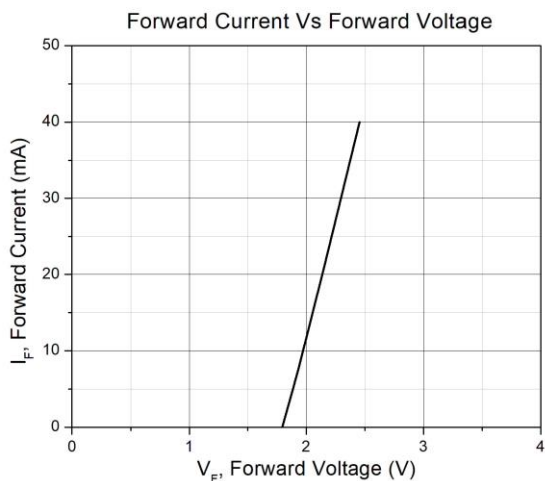

Figure 1

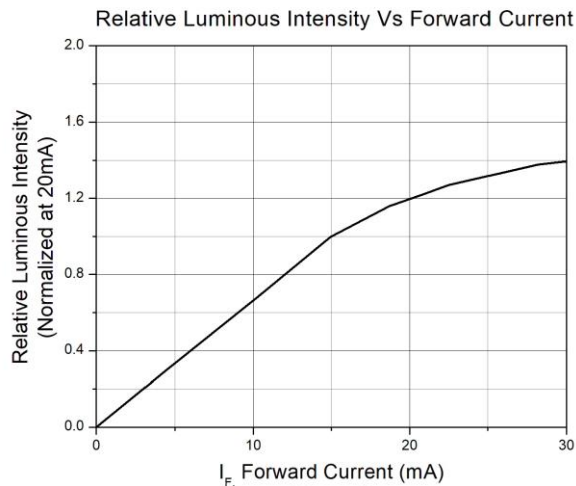

Figure 2

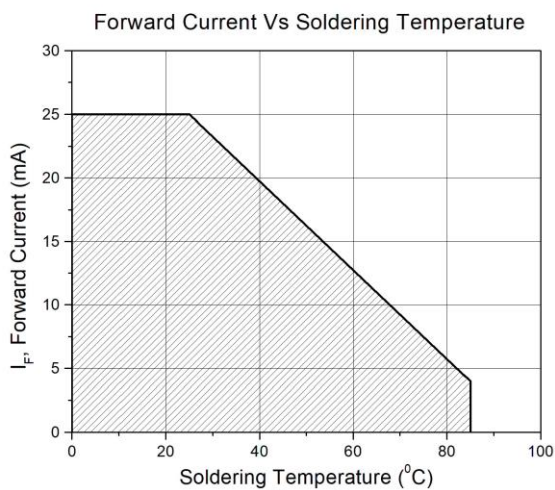

Figure 3

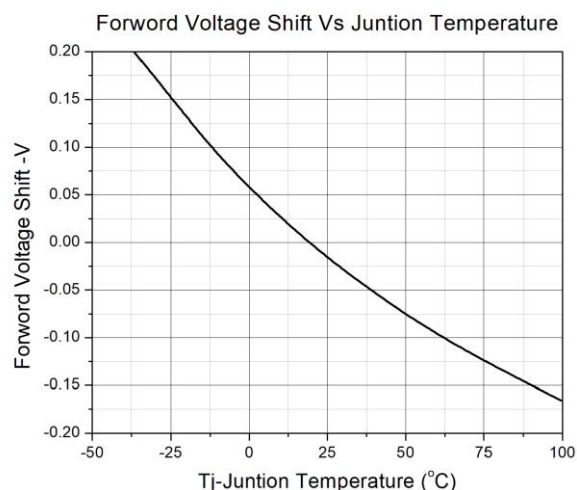

Figure 4

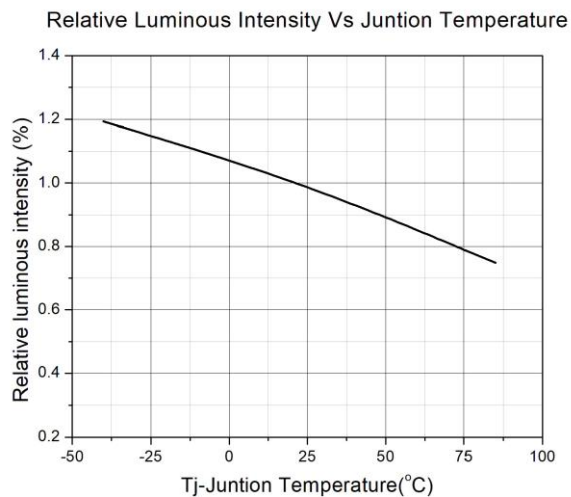

Figure 5

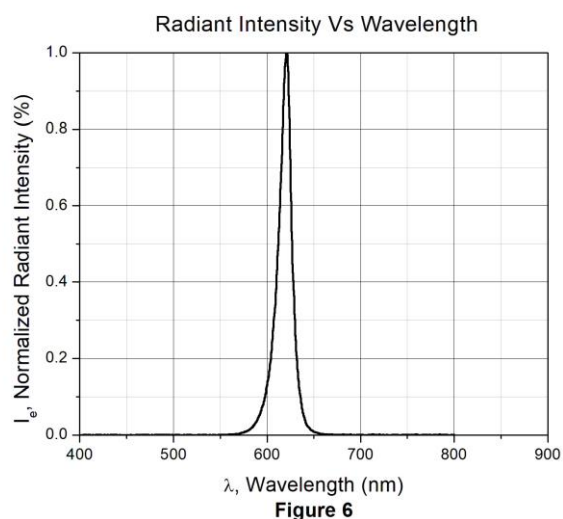

Figure 6



Typical Characteristic Curves

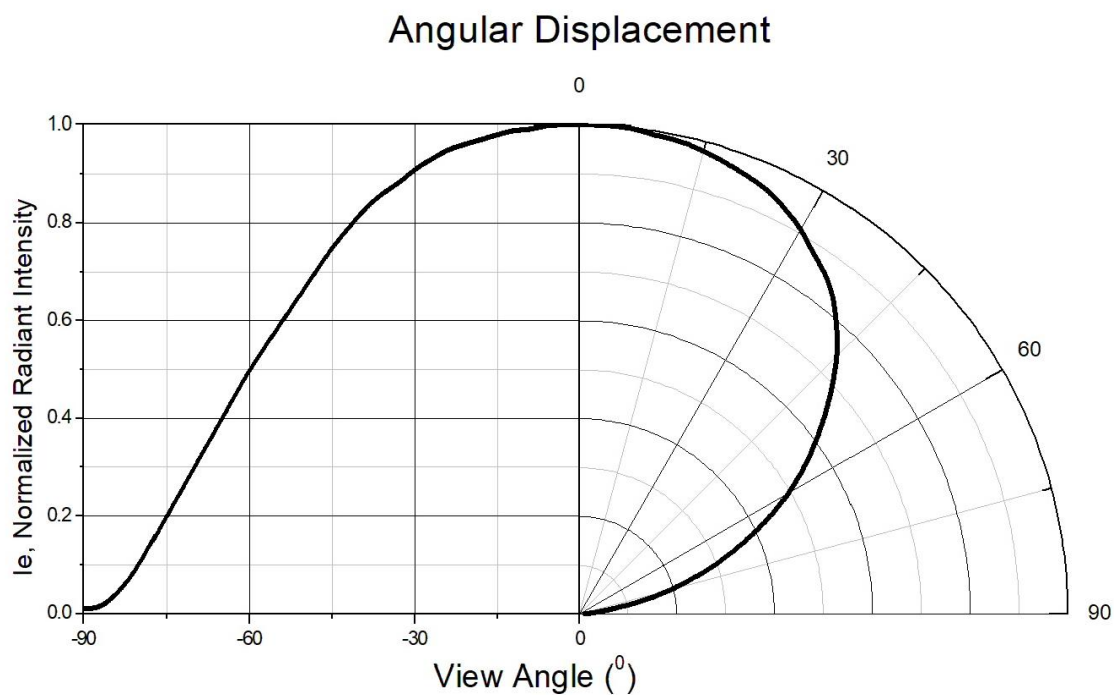
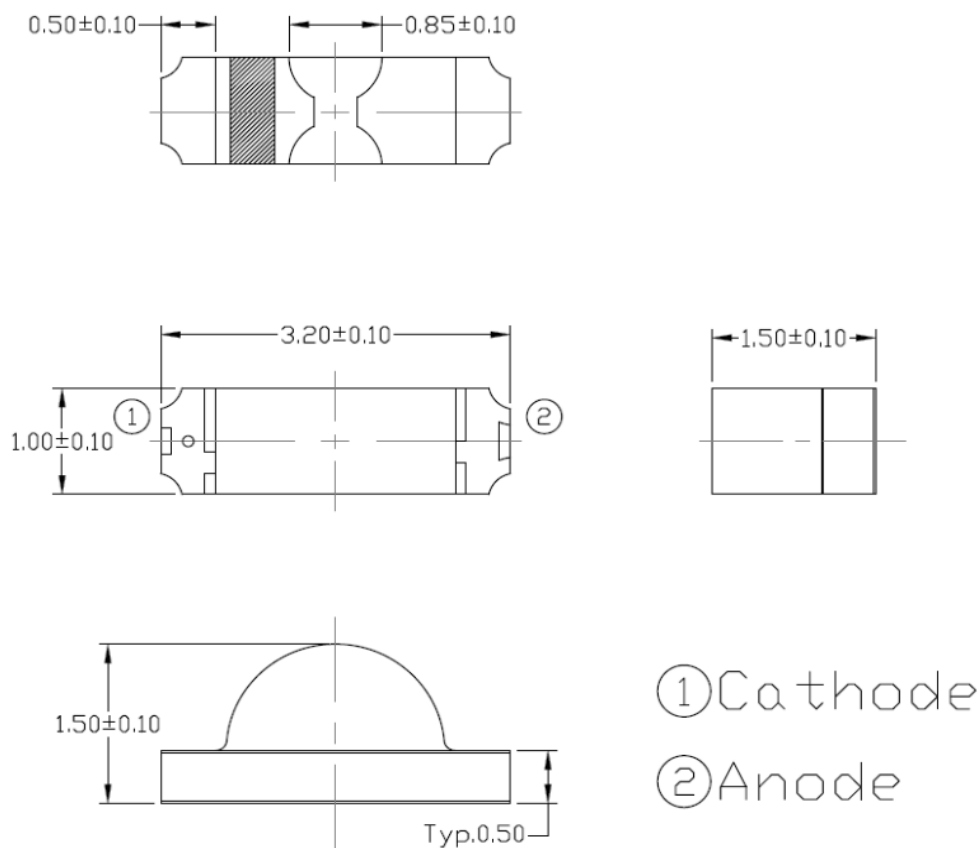

Figure 7



Package Dimension *All dimensions are in mm, unless otherwise stated*



Note: Tolerance unless mentioned is ± 0.1 mm.

Recommended Soldering Mask *All dimensions are in mm, unless otherwise stated*

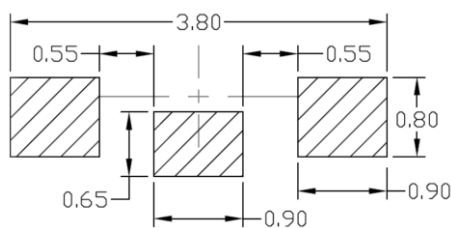

Note: Tolerance unless mentioned is ± 0.1 mm.

Ordering Information

Part Number	Description	Quantity
AP321015-ASC3	Tape & Reel	3000 pcs



Label Form Specification



CPN : Customer Part Number
 Part no: CTM Production Number
 Serial no: Production Number
 Lot no: Lot number
 Q'ty: Packing Quantity
 Date Code: Manufacture Date
 IV : Bin Code of Luminous Intensity
 WD : Bin Code of Dominant Wavelength
 VF : Bin Code of Forward Voltage
 MADE IN CHINA: Production Place

Storage Condition

1. Do not open moisture proof bag before the products are ready to use.
2. The moisture barrier bag should be stored at 30°C and 90%R.H. max. before opening.
Shelf life of non-opened bag is 12 months after the bag sealing date.
3. After opening the moisture barrier bag floor life is 1 year at 30°C/60%RH. max. Unused LEDs should be resealed into moisture barrier bag. (Refer to J-STD-020 Standard)
4. If the moisture absorbent material has faded away or the LEDs have exceeded the storage time, baking treatment should be performed using the J-STD-033 Standard conditions.



Reflow Profile

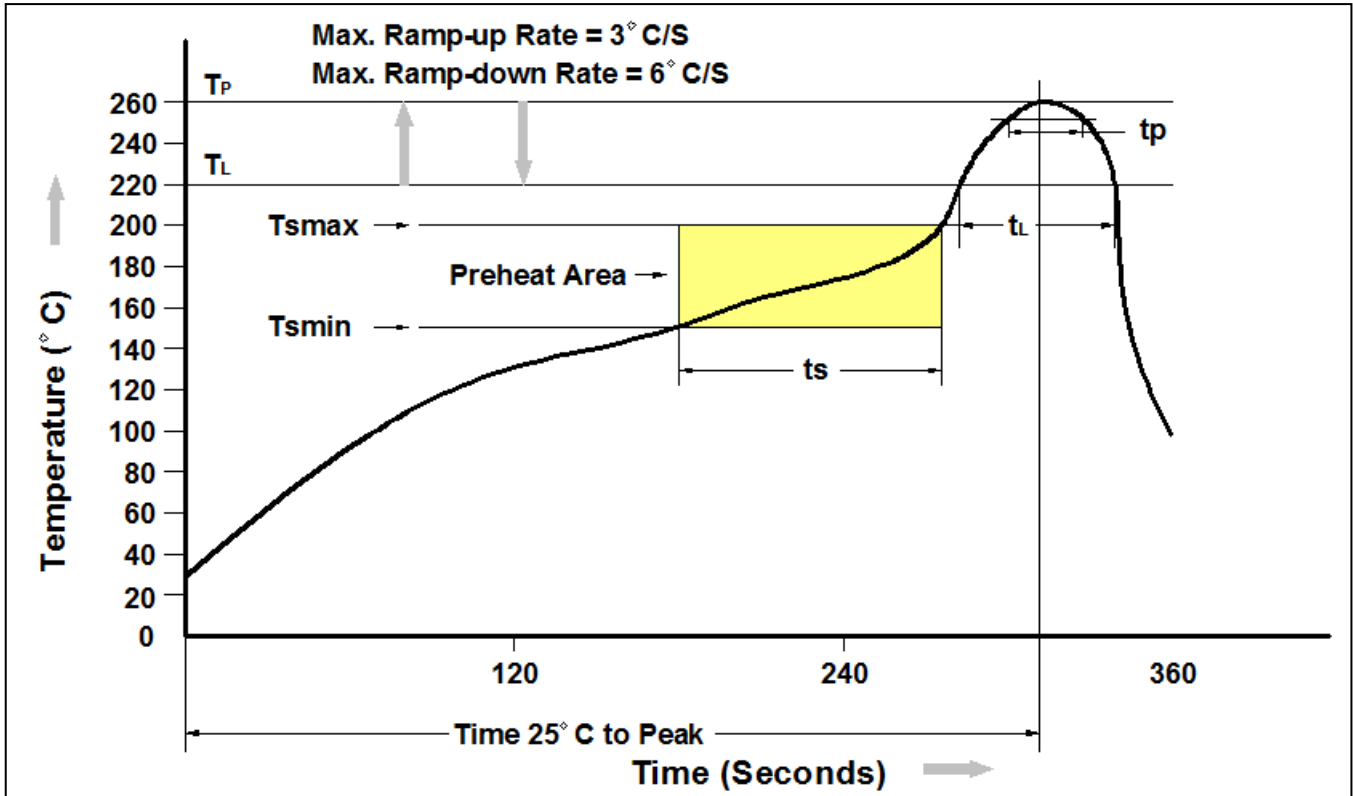

Profile Feature	Pb-Free Assembly Profile
Temperature Min. (Tsmmin)	150°C
Temperature Max. (Tsmmax)	200°C
Time (ts) from (Tsmmin to Tsmmax)	60-120 seconds
Ramp-up Rate (tl to tp)	3°C/second max.
Liquidous Temperature (Tl)	217°C
Time (tl) Maintained Above (Tl)	60 – 150 seconds
Peak Body Package Temperature	260°C +0°C / -5°C
Time (tp) within 5°C of 260°C	30 seconds
Ramp-down Rate (TP to TL)	6°C/second max
Time 25°C to Peak Temperature	8 minutes max.



DISCLAIMER

CT MICRO RESERVES THE RIGHT TO MAKE CHANGES WITHOUT FURTHER NOTICE TO ANY PRODUCTS HEREIN TO IMPROVE RELIABILITY, FUNCTION OR DESIGN. CT MICRO DOES NOT ASSUME ANY LIABILITY ARISING OUT OF THE APPLICATION OR USE OF ANY PRODUCT OR CIRCUIT DESCRIBED HEREIN; NEITHER DOES IT CONVEY ANY LICENSE UNDER ITS PATENT RIGHTS, NOR THE RIGHTS OF OTHERS.

CT MICRO ARE NOT AUTHORIZED FOR USE AS CRITICAL COMPONENTS IN LIFE SUPPORT DEVICES OR SYSTEMS WITHOUT EXPRESS WRITTEN APPROVAL OF CT MICRO INTERNATIONAL CORPORATION.

- 1. Life support devices or systems are devices or systems which, (a) are intended for surgical implant into the body, or (b) support or sustain life, or (c) whose failure to perform when properly used in accordance with instruction for use provided in the labelling, can be reasonably expected to result in significant injury to the user.*
- 2. A critical component is any component of a life support device or system whose failure to perform can be reasonably expected to cause the failure of the life support device or system, or to affect its safety or effectiveness.*