



BP3015Q12-B10

SMD Type Blue Emitter

Features

- Small double-end package
- Viewing Angle = $\pm 55^\circ$
- High reliability
- Ultra bright Blue
- RoHS compliance

Applications

- Blue sensor

Description

The BP3015Q12-B10 is an InGaN Blue LED housed in a miniature SMD package. The device has a peak wavelength of 465nm LED.

Package Outline

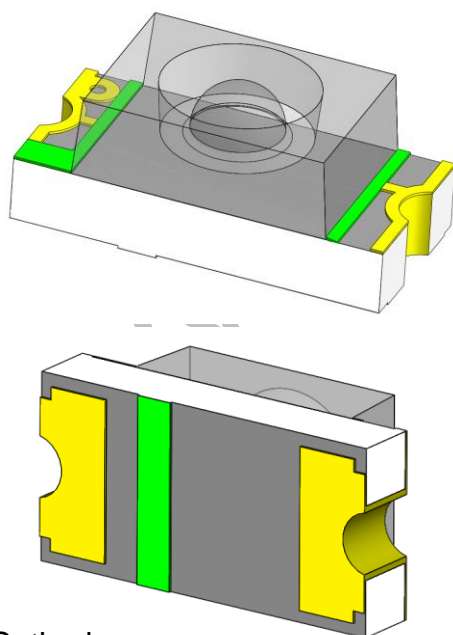

Cathode

(Blue LED)

Anode

(Blue LED)

Schematic

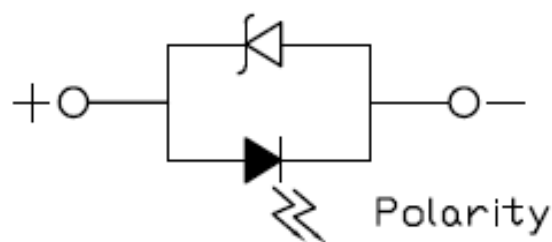



BP3015Q12-B10

SMD Type Blue Emitter

Absolute Maximum Rating at 25°C

Symbol	Parameters	Ratings	Units	Notes
I _F	Continuous Forward Current	20	mA	
V _R	Reverse Voltage	5	V	
T _{opr}	Operating Temperature	-40 ~ +85	°C	
T _{stg}	Storage Temperature	-40 ~ +100	°C	
T _{sol}	Soldering Temperature	260	°C	1
P _D	Power Dissipation at(or below) 25°C Free Air Temperature	76	mW	

Electro-Optical Characteristics *TA = 25°C (unless otherwise specified)*

Optical Characteristics

Symbol	Parameters	Test Conditions	Min	Typ	Max	Units	Notes
I _v	Luminous Intensity	I _F =5mA	45	-	130	mcd	2
λ _p	Peak Wavelength	I _F =5mA	-	465	-	nm	
λ _d	Dominant Wavelength	I _F =5mA	465	-	475	nm	3
Δλ	Spectral Bandwidth	I _F =5mA	-	17	-	nm	
θ _{1/2}	Angle of Half Intensity	I _F =5mA	-	±55	-	deg	

Electrical Characteristics

Symbol	Parameters	Test Conditions	Min	Typ	Max	Units	Notes
V _F	Blue LED Forward Voltage	I _F =5mA	2.4	2.65	3.0	V	4
		I _F =20mA	2.6	-	3.8	V	
V _{FZ}	Zener LED Forward Voltage	I _{FZ} =20mA	0.6	-	1.2	V	

Notes:

- Soldering time ≤ 5 seconds.
- Tolerance of Luminous intensity: ±10%

Bin Code	P	Q
Min	45	71
Max	71	130



BP3015Q12-B10

SMD Type Blue Emitter

3. Tolerance of Dominant Wavelength: $\pm 1\text{nm}$

Bin Code	AB	AC
Min	465	470
Max	470	475

4. Tolerance of Forward Voltage: $\pm 0.1\text{V}$

Bin Code	D1	D2	D3
Min	2.4	2.6	2.8
Max	2.6	2.8	3.0

Typical Characteristic Curves

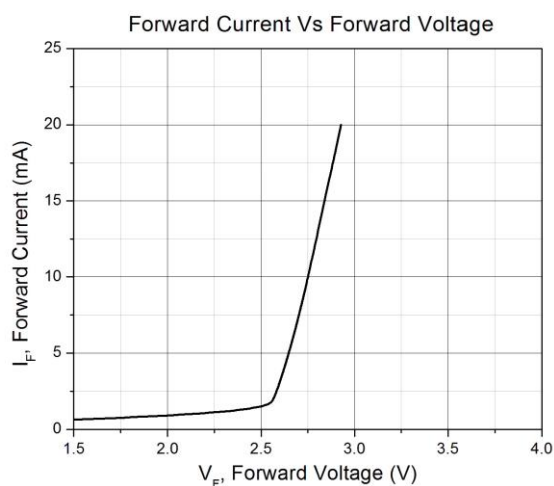

Figure 1

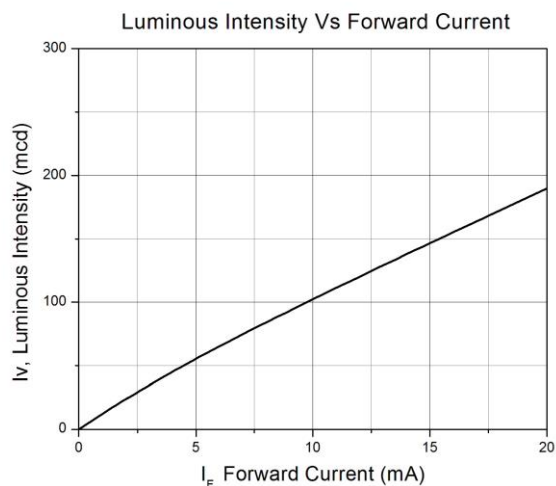

Figure 2

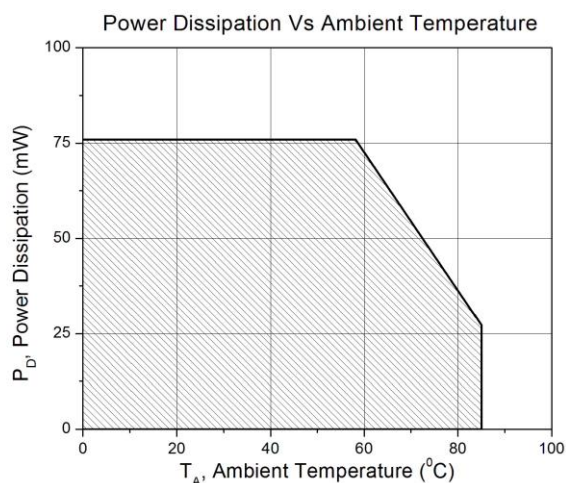

Figure 3

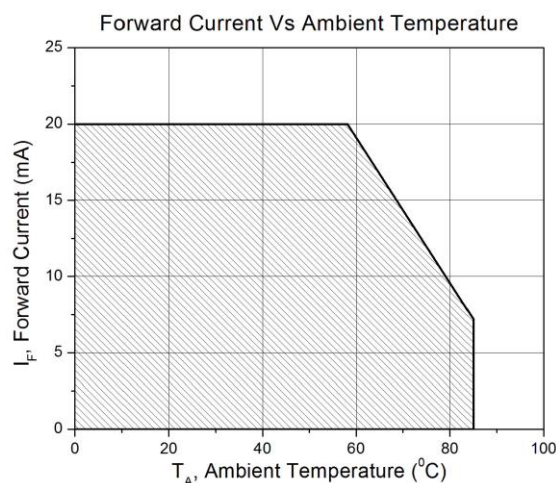
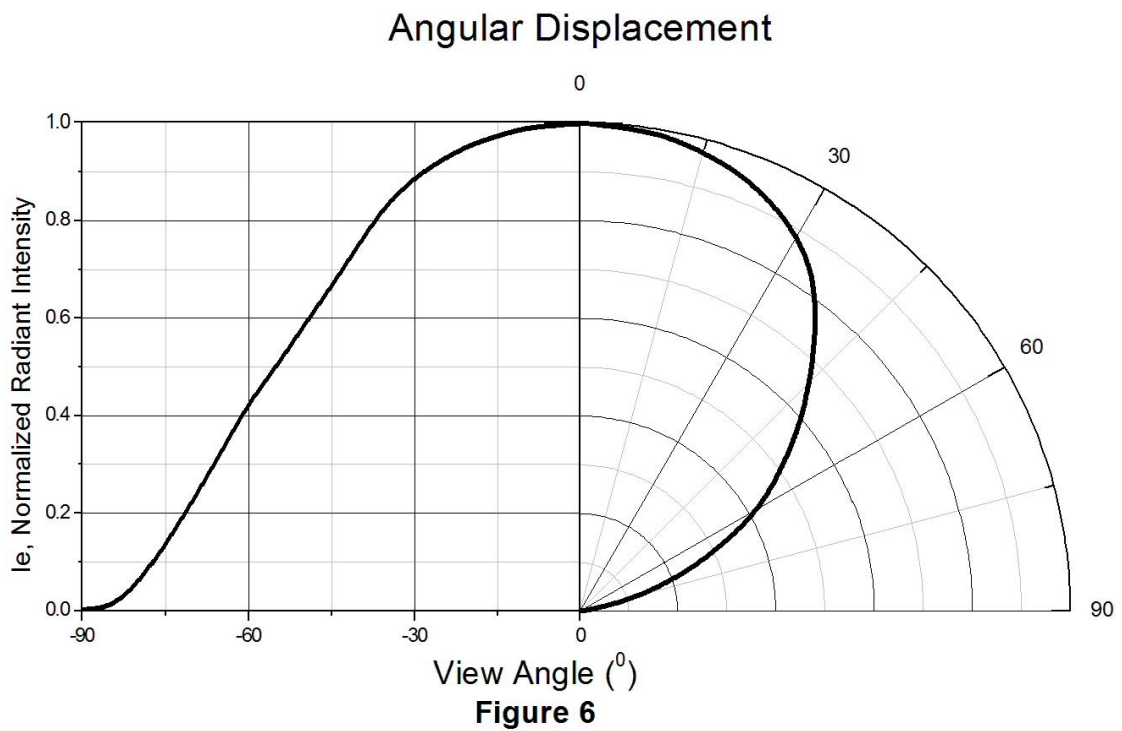
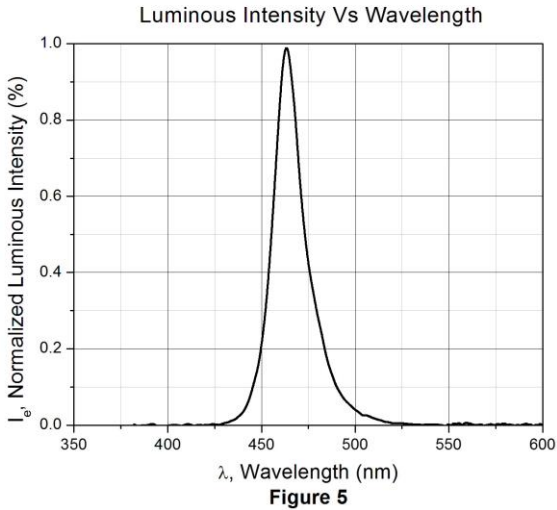

Figure 4



BP3015Q12-B10
SMD Type Blue Emitter





BP3015Q12-B10

SMD Type Blue Emitter

Package Dimension *All dimensions are in mm, unless otherwise stated*

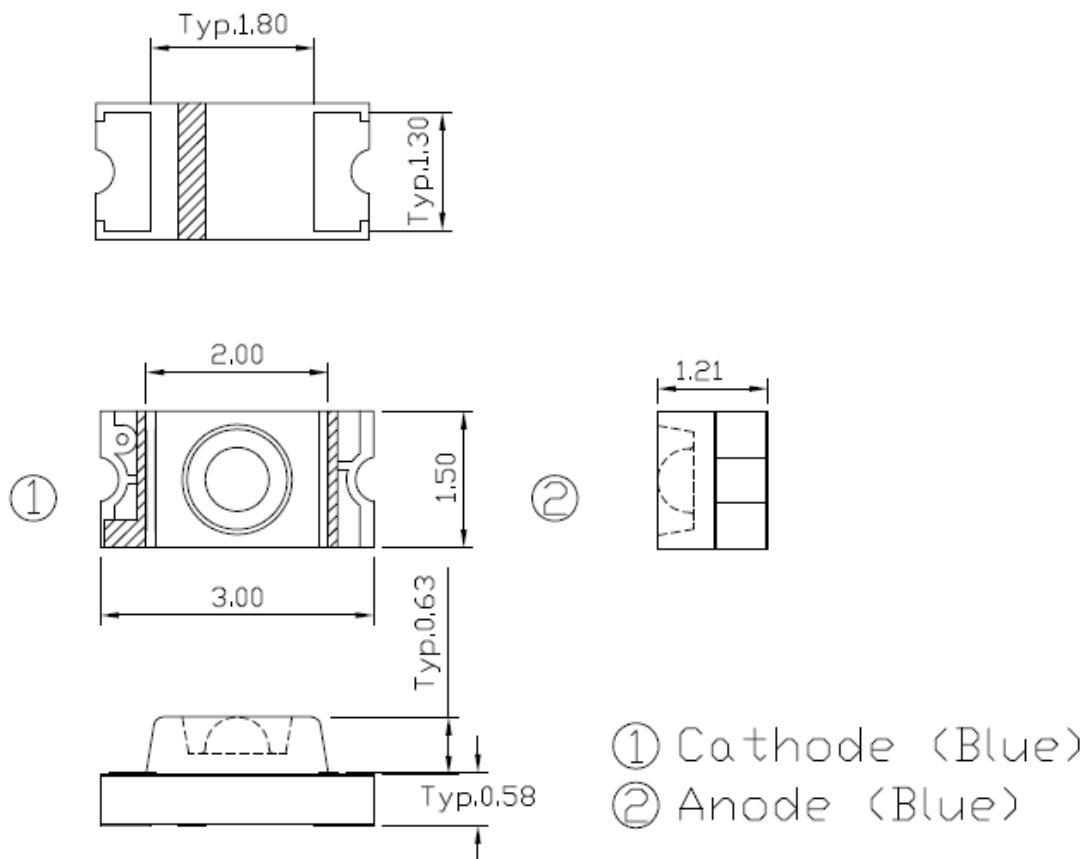

Recommended Soldering Mask *All dimensions are in mm, unless otherwise stated*

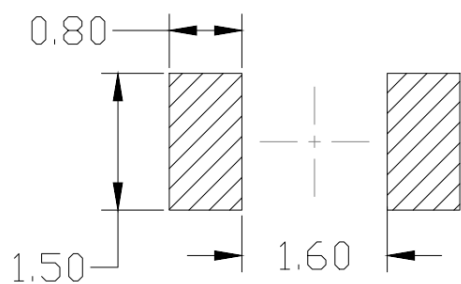

Ordering Information

Part Number	Description	Quantity
BP3015Q12-B10	Tape & Reel	3000 pcs



BP3015Q12-B10

SMD Type Blue Emitter

Reel Dimension *All dimensions are in mm, unless otherwise stated*

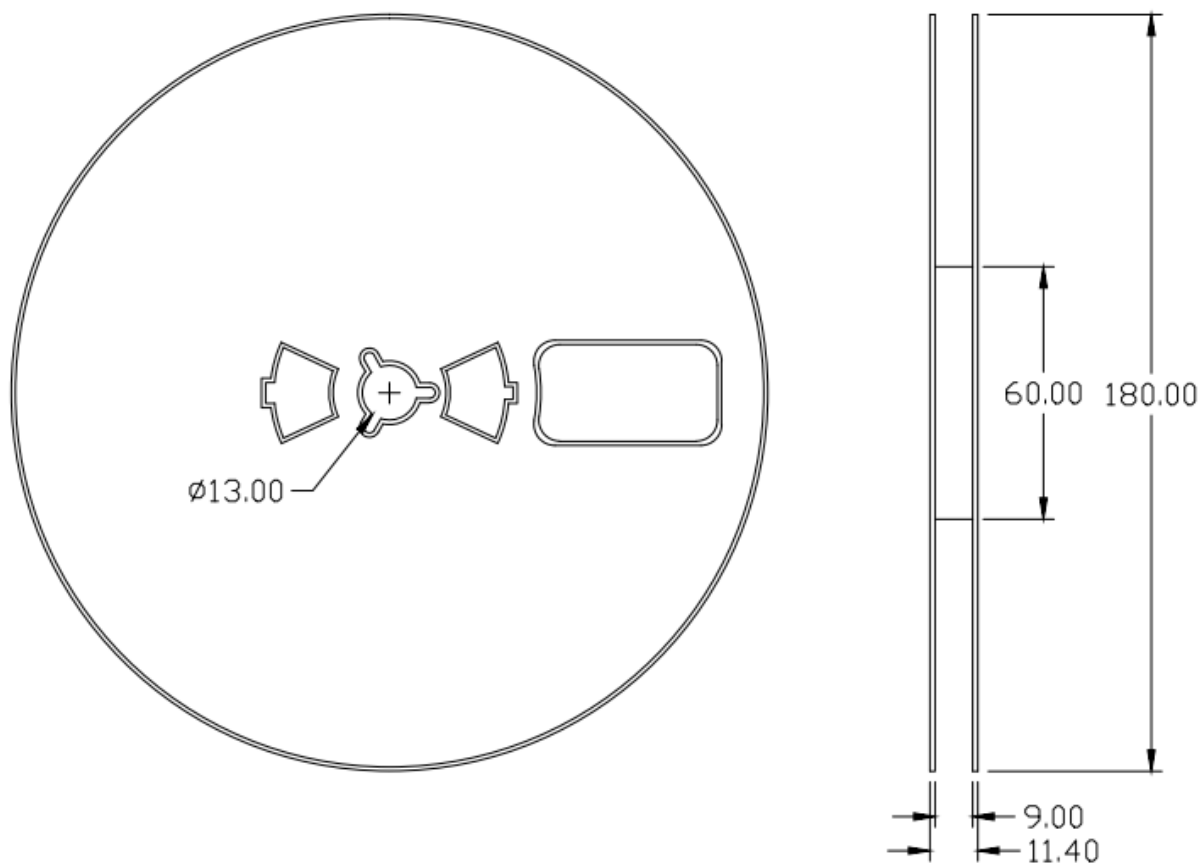

Tape Dimension *All dimensions are in mm, unless otherwise stated*

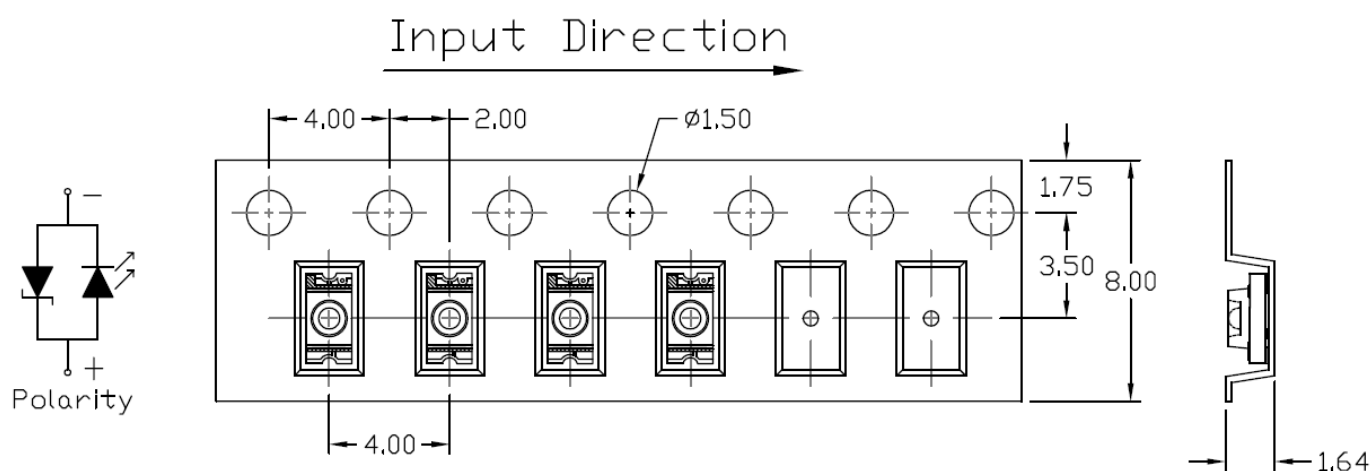



Label Form Specification

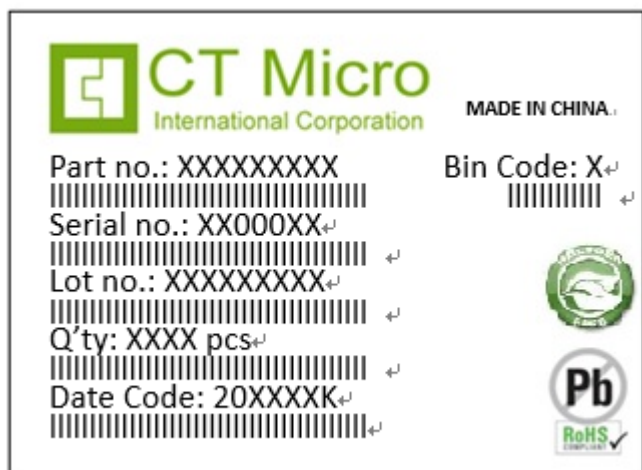

Part no: CTM Production Number
Serial no: Production Number
Lot no: Lot number
Q'ty: Packing Quantity
Date Code: Manufacture Date
Bin Code: Iv Ranks
MADE IN CHINA: Production Place

Storage Condition

1. Do not open moisture proof bag before the products are ready to use.
2. The moisture barrier bag should be stored at 30°C and 90%R.H. max. before opening.
Shelf life of non-opened bag is 12 months after the bag sealing date.
3. After opening the moisture barrier bag floor life is 168h at 30°C/60%RH. max. Unused LEDs should be resealed into moisture barrier bag. (Refer to J-STD-020 Standard)
4. If the moisture absorbent material has faded away or the LEDs have exceeded the storage time, baking treatment should be performed using the J-STD-033 Standard conditions.



Reflow Profile

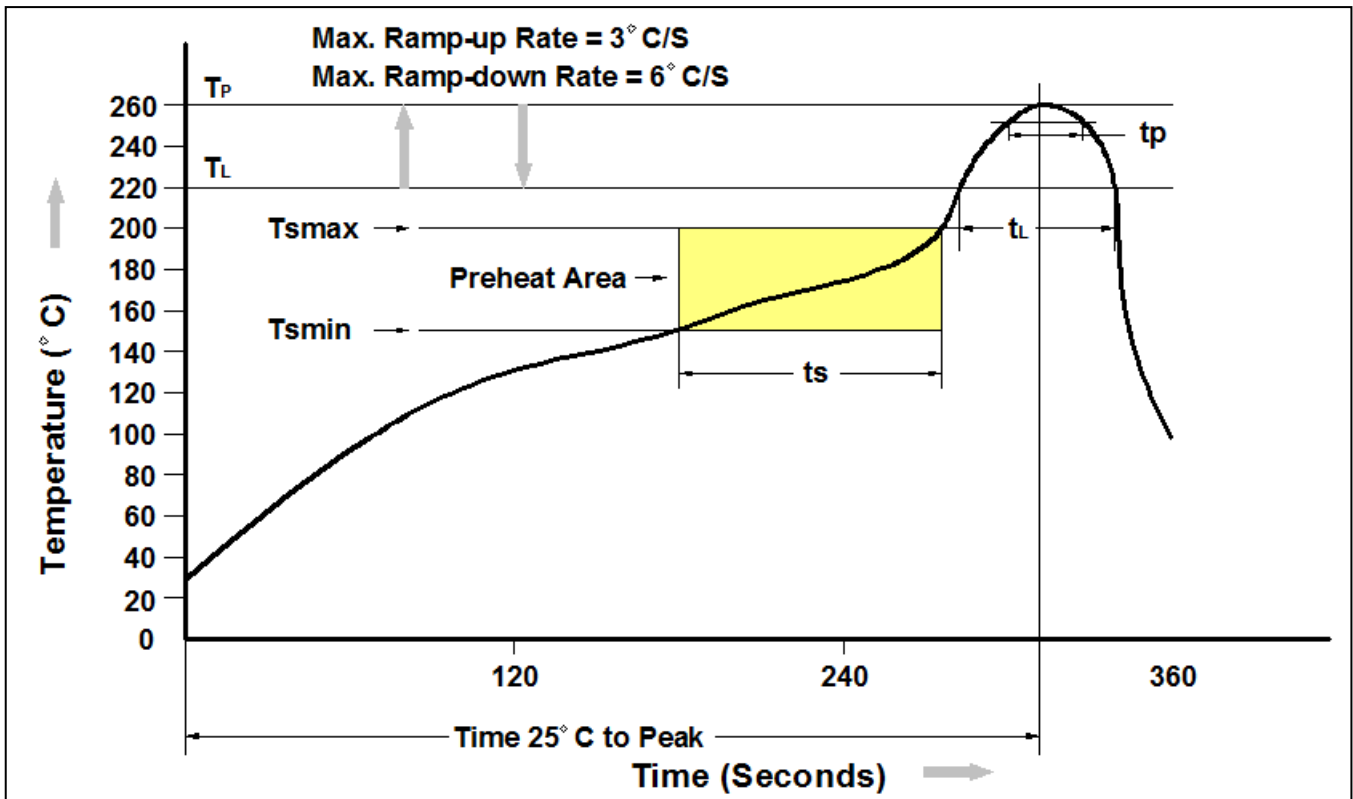

Profile Feature	Pb-Free Assembly Profile
Temperature Min. (T _{sm})	150°C
Temperature Max. (T _{sm})	200°C
Time (t _s) from (T _{sm} to T _{sm})	60-120 seconds
Ramp-up Rate (t _L to t _P)	3°C/second max.
Liquidous Temperature (T _L)	217°C
Time (t _L) Maintained Above (T _L)	60 – 150 seconds
Peak Body Package Temperature	260°C +0°C / -5°C
Time (t _P) within 5°C of 260°C	30 seconds
Ramp-down Rate (T _P to T _L)	6°C/second max
Time 25°C to Peak Temperature	8 minutes max.



DISCLAIMER

CT MICRO RESERVES THE RIGHT TO MAKE CHANGES WITHOUT FURTHER NOTICE TO ANY PRODUCTS HEREIN TO IMPROVE RELIABILITY, FUNCTION OR DESIGN. CT MICRO DOES NOT ASSUME ANY LIABILITY ARISING OUT OF THE APPLICATION OR USE OF ANY PRODUCT OR CIRCUIT DESCRIBED HEREIN; NEITHER DOES IT CONVEY ANY LICENSE UNDER ITS PATENT RIGHTS, NOR THE RIGHTS OF OTHERS.

CT MICRO ARE NOT AUTHORIZED FOR USE AS CRITICAL COMPONENTS IN LIFE SUPPORT DEVICES OR SYSTEMS WITHOUT EXPRESS WRITTEN APPROVAL OF CT MICRO INTERNATIONAL CORPORATION.

- 1. Life support devices or systems are devices or systems which, (a) are intended for surgical implant into the body, or (b) support or sustain life, or (c) whose failure to perform when properly used in accordance with instruction for use provided in the labelling, can be reasonably expected to result in significant injury to the user.*
- 2. A critical component is any component of a life support device or system whose failure to perform can be reasonably expected to cause the failure of the life support device or system, or to affect its safety or effectiveness.*