



BRGP160406-PASC3

Multi-Wavelength SMD Type

Features

- Side view 0602 package
- Wide viewing angle
- BRG individual control
- High reliability
- RoHS compliance

Applications

- General lighting
- Indoor signage display applications
- Switch light
- Decorative and Entertainment lighting

Description

The BRGP160406-PASC3 is a high brightness device designed for demanding applications in efficiency and reduced space. An ideal device in emphasizing visual effects, advertisement, decoration as well as general backlighting needs.

Package Outline

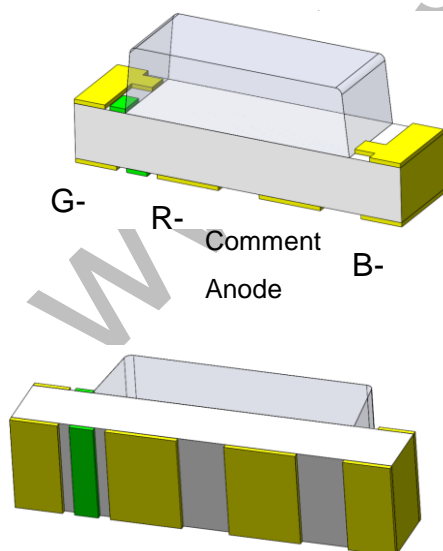

Schematic

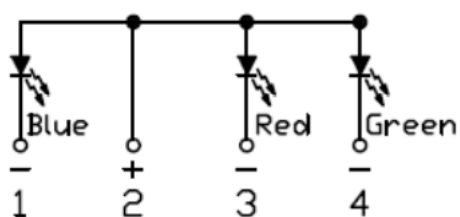



BRGP160406-PASC3

Multi-Wavelength SMD Type

Absolute Maximum Rating at 25°C

Symbol	Parameters		Ratings	Units	Notes
I _F	Continuous Forward Current	B	25	mA	
		R	25		
		G	25		
I _{FP}	Peak Forward Current	B	60	mA	1
		R	60		
		G	60		
V _R	Reverse Voltage		10	V	
T _{opr}	Operating Temperature		-40 ~ +85	°C	
T _{stg}	Storage Temperature		-40 ~ +100	°C	
T _{sol}	Soldering Temperature		260	°C	2
P _D	Power Dissipation at(or below) 25°C Free Air Temperature	B	95	mW	
		R	60		
		G	95		

Electro-Optical Characteristics *T_A = 25°C (unless otherwise specified)*

Optical Characteristics (Blue)

Symbol	Parameters	Test Conditions	Min	Typ	Max	Units	Notes
I _v	Luminous Intensity	I _F =20mA	57	-	140	mcd	3
λ _d	Dominant Wavelength	I _F =20mA	460	-	475	nm	4
θ _{1/2}	Angle of Half Intensity	I _F =20mA	-	±65	-	deg	

Electrical Characteristics (Blue)

Symbol	Parameters	Test Conditions	Min	Typ	Max	Units	Notes
V _F	Forward Voltage	I _F =20mA	2.6	-	3.4	V	
I _R	Reverse Current	V _R =5V	-	-	1	μA	



BRGP160406-PASC3

Multi-Wavelength SMD Type

Optical Characteristics (Red)

Symbol	Parameters	Test Conditions	Min	Typ	Max	Units	Notes
I _v	Luminous Intensity	I _F =20mA	45	-	112	mcd	3
λ _d	Dominant Wavelength	I _F =20mA	-	621	-	nm	
θ _{1/2}	Angle of Half Intensity	I _F =20mA	-	±65	-	deg	

Electrical Characteristics (Red)

Symbol	Parameters	Test Conditions	Min	Typ	Max	Units	Notes
V _F	Forward Voltage	I _F =20mA	1.7	-	2.4	V	
I _R	Reverse Current	V _R =5V	-	-	1	μA	

Optical Characteristics (Green)

Symbol	Parameters	Test Conditions	Min	Typ	Max	Units	Notes
I _v	Luminous Intensity	I _F =20mA	180	-	360	mcd	3
λ _d	Dominant Wavelength	I _F =20mA	510	-	530	nm	4
θ _{1/2}	Angle of Half Intensity	I _F =20mA	-	±65	-	deg	

Electrical Characteristics (Green)

Symbol	Parameters	Test Conditions	Min	Typ	Max	Units	Notes
V _F	Forward Voltage	I _F =20mA	2.6	-	3.4	V	
I _R	Reverse Current	V _R =5V	-	-	1	μA	

Notes:

1. I_{FP} Conditions--Pulse Width ≤ 100μs and Duty ≤ 10%.
2. Soldering time ≤ 10 seconds.



BRGP160406-PASC3 Multi-Wavelength SMD Type

3. Bin Range of Luminous Intensity

Blue				
Bin Code	Min	Max	Unit	Condition
PA	57	90	mcd	I _F =20mA
QA	90	140		
Red				
P	45	72	mcd	I _F =20mA
Q	72	112		
Green				
AS1	180	225	mcd	I _F =20mA
AS2	225	285		
AT1	285	360		

Tolerance of Luminous Intensity $\pm 10\%$

4. Bin Range of Dominant Wavelength

Blue				
Bin Code	Min	Max	Unit	Condition
A5	460	465	nm	I _F =20mA
A6	465	470		
A7	470	475		
Green				
A3	510	515	nm	I _F =20mA
A4	515	520		
A5	520	525		
A6	525	530		

Tolerance of Dominant Wavelength: $\pm 1\text{nm}$.



Typical Characteristic Curves

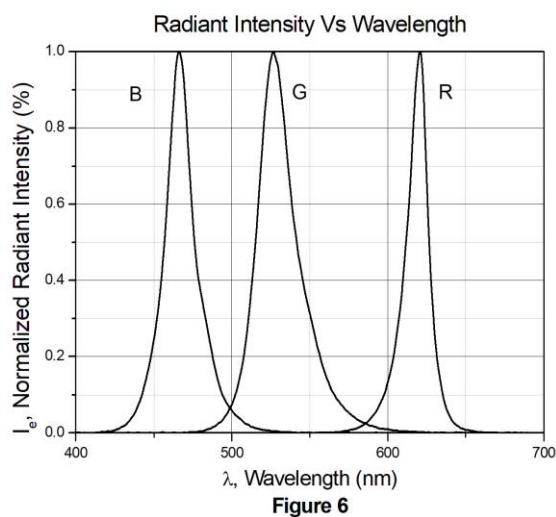
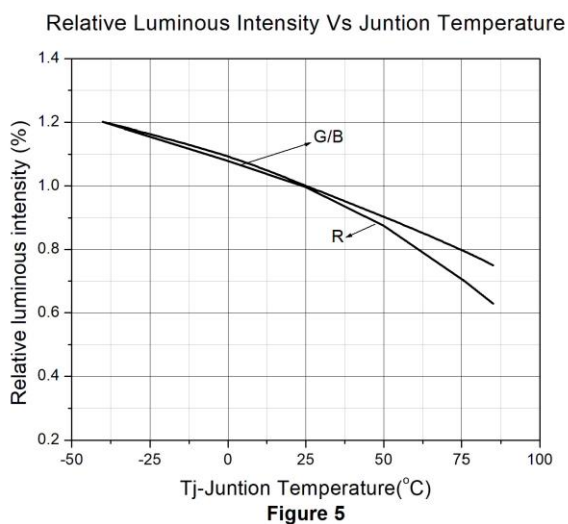
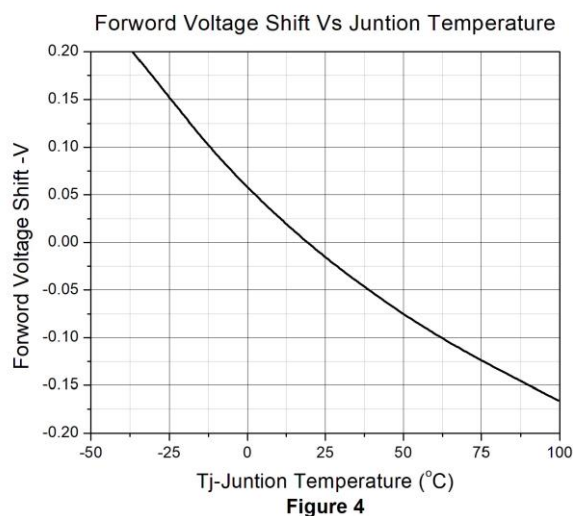
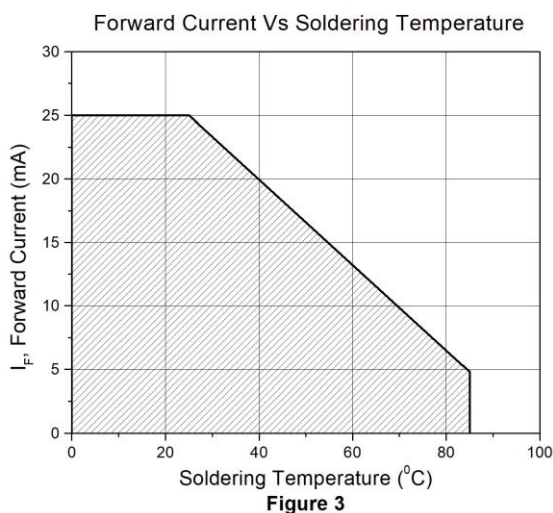
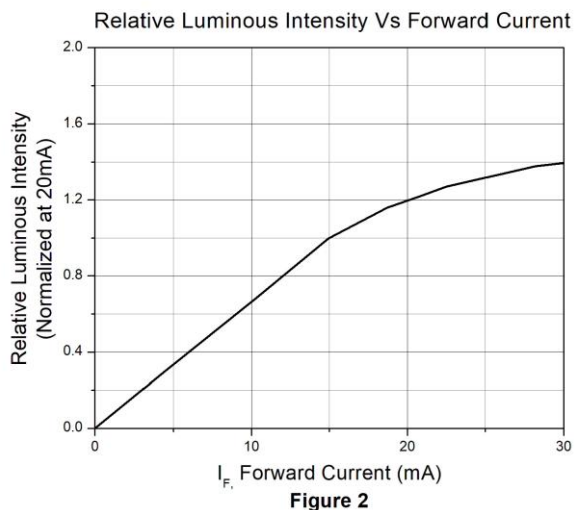
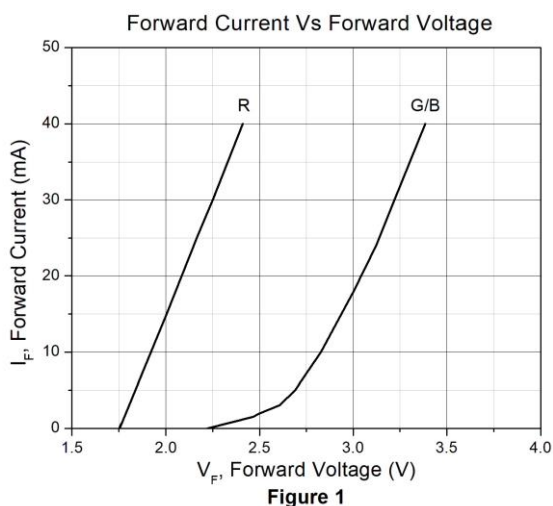



Typical Characteristic Curves

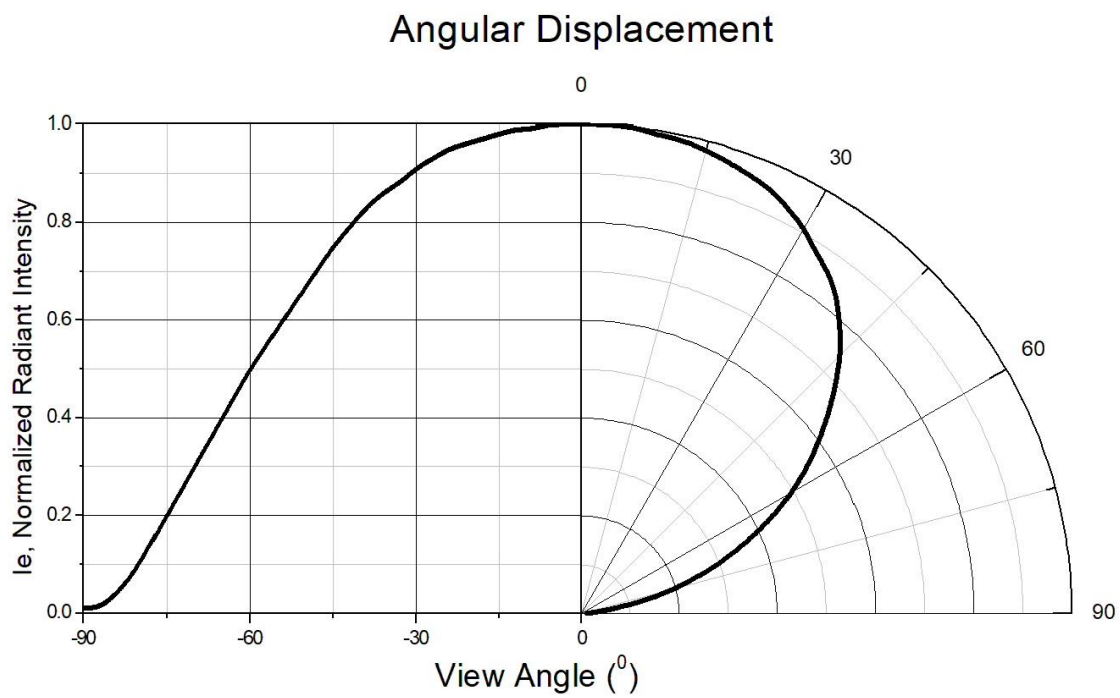

Figure 7

www.sig



BRGP160406-PASC3

Multi-Wavelength SMD Type

Package Dimension *All dimensions are in mm, unless otherwise stated*

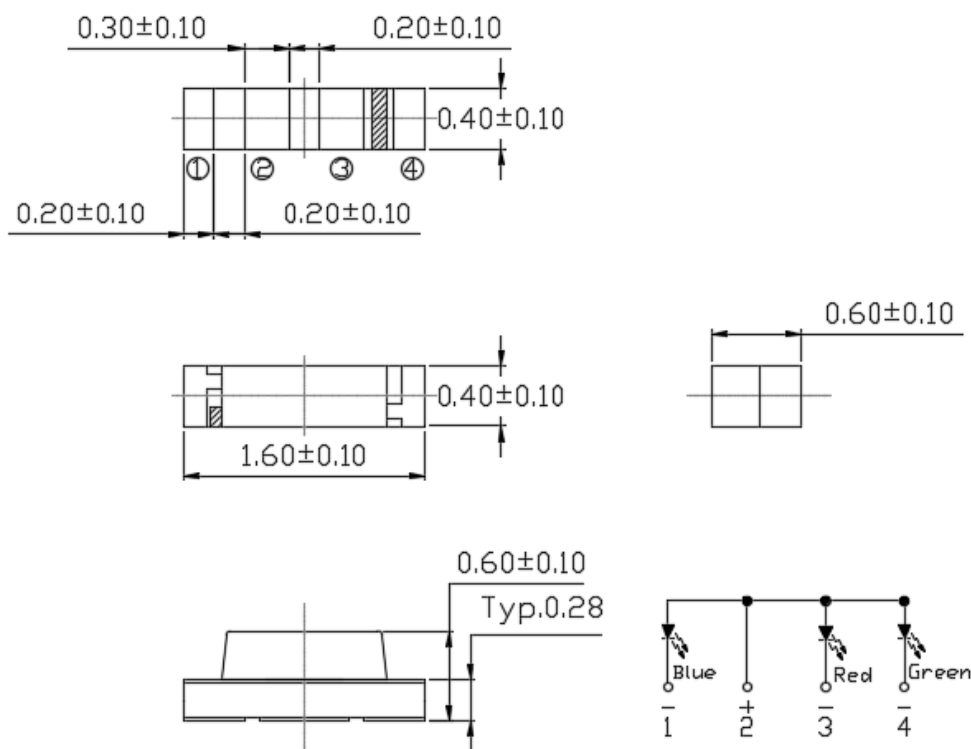

Note: Tolerance unless mentioned is ± 0.1 mm

Recommended Soldering Mask *All dimensions are in mm, unless otherwise stated*

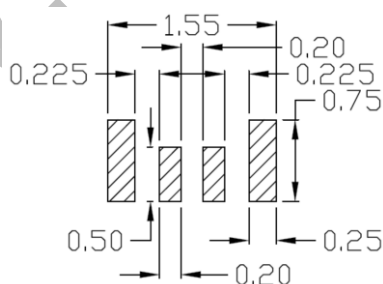

Note: Tolerance unless mentioned is ± 0.1 mm

Ordering Information

Part Number	Description	Quantity
BRGP160406-PASC3	Tape & Reel	3000 pcs



BRGP160406-PASC3

Multi-Wavelength SMD Type

Reel Dimension

All dimensions are in mm, unless otherwise stated

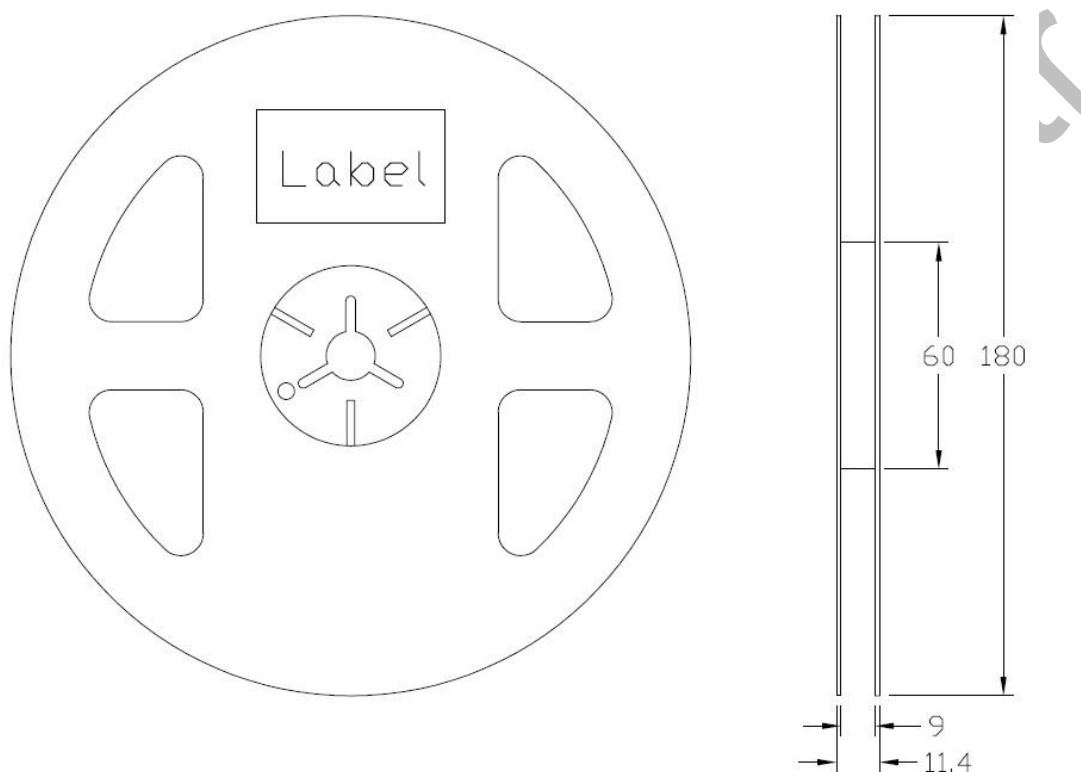

Tape Dimension

All dimensions are in mm, unless otherwise stated

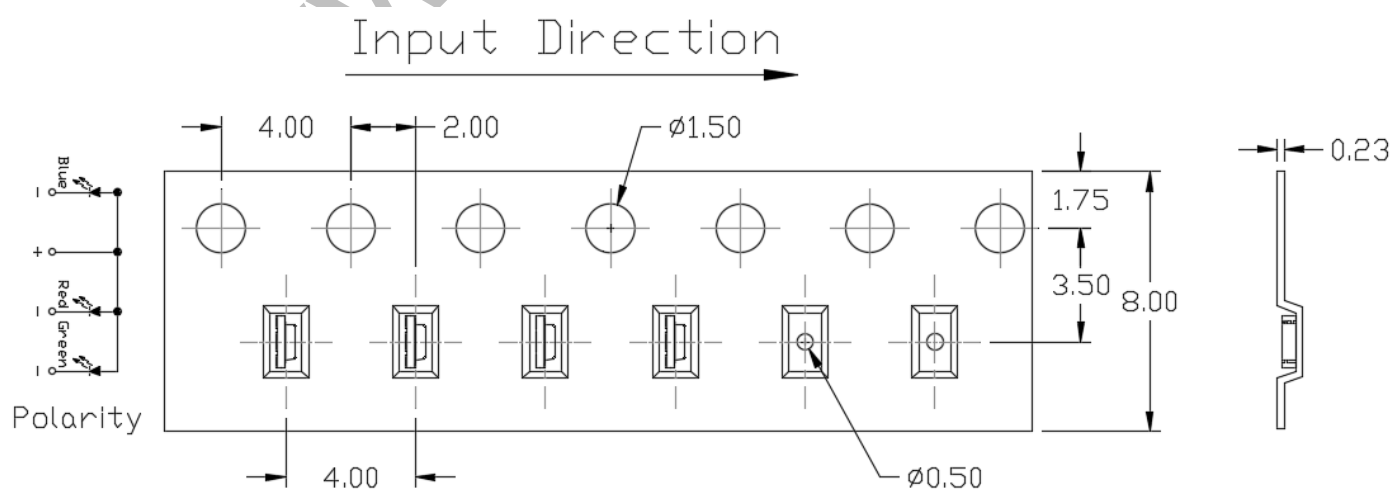

Note: Tolerance unless mentioned is ± 0.1 mm



Label Form Specification

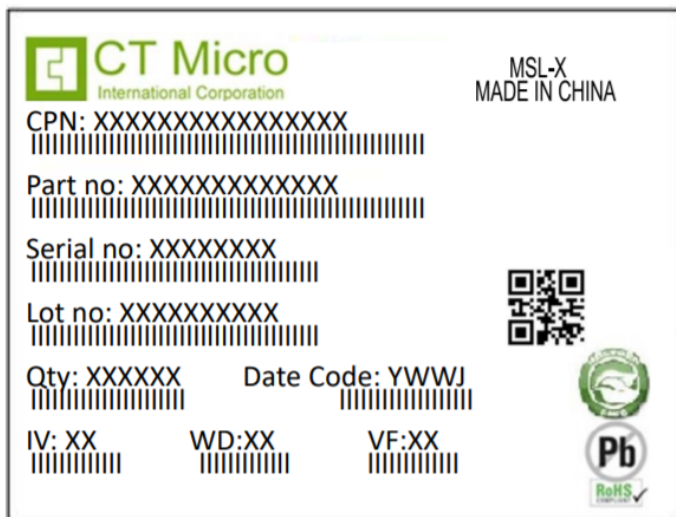

CPN : Customer Part Number
Part no: CTM Production Number
Serial no: Production Number
Lot no: Lot number
Q'ty: Packing Quantity
Date Code: Manufacture Date
IV : Bin Code of Luminous Intensity
WD : Bin Code of Dominant Wavelength
VF : Bin Code of Forward Voltage
MADE IN CHINA: Production Place

Storage Condition

1. Do not open moisture proof bag before the products are ready to use.
2. The moisture barrier bag should be stored at 30°C and 90%R.H. max. before opening.
Shelf life of non-opened bag is 12 months after the bag sealing date.
3. After opening the moisture barrier bag floor life is 1 year at 30°C/60%RH. max. Unused LEDs should be resealed into moisture barrier bag. (Refer to J-STD-020 Standard)
4. If the moisture absorbent material has faded away or the LEDs have exceeded the storage time, baking treatment should be performed using the J-STD-033 Standard conditions.



BRGP160406-PASC3

Multi-Wavelength SMD Type

Reflow Profile

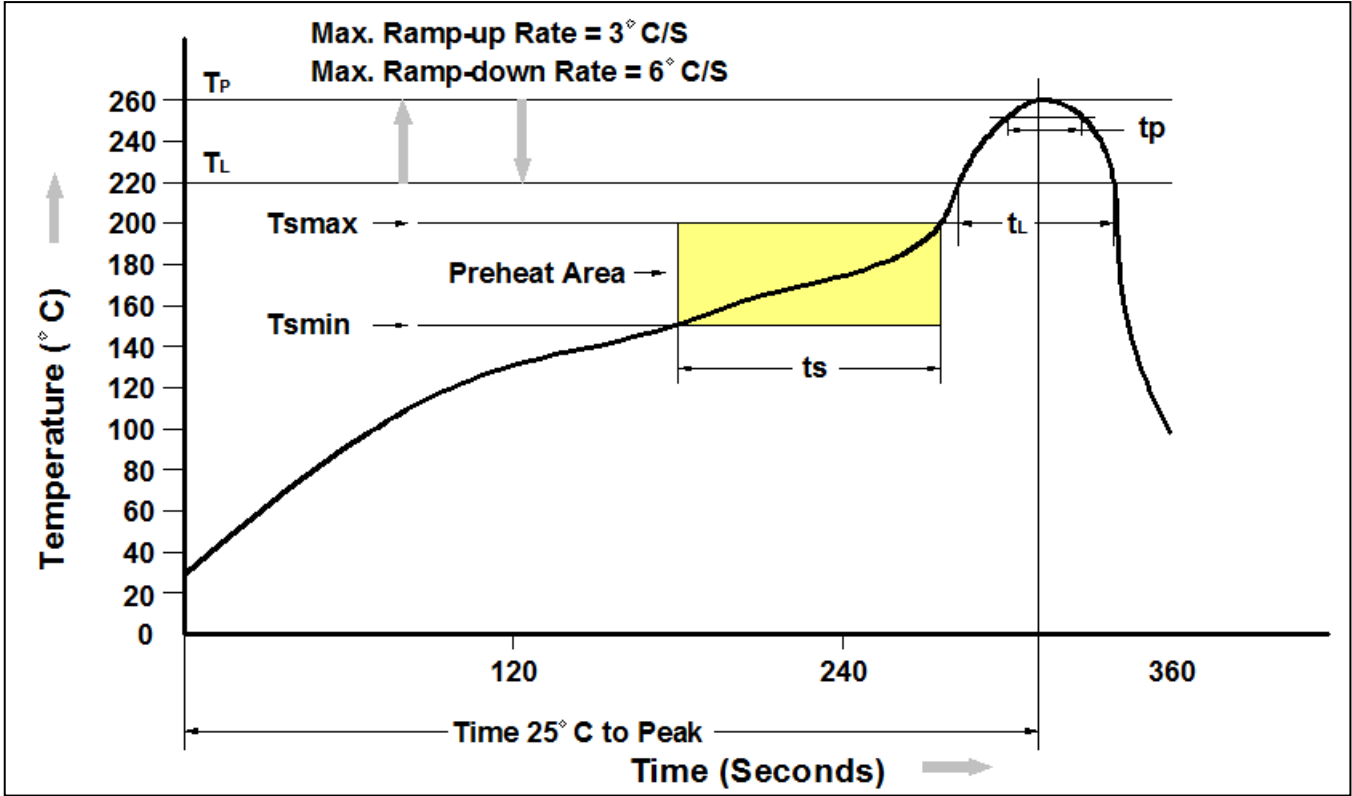

Profile Feature	Pb-Free Assembly Profile
Temperature Min. (Tsmín)	150°C
Temperature Max. (Tsmáx)	200°C
Time (ts) from (Tsmín to Tsmáx)	60-120 seconds
Ramp-up Rate (tL to tp)	3°C/second max.
Liquidous Temperature (TL)	217°C
Time (tL) Maintained Above (TL)	60 – 150 seconds
Peak Body Package Temperature	260°C +0°C / -5°C
Time (tp) within 5°C of 260°C	30 seconds
Ramp-down Rate (TP to TL)	6°C/second max
Time 25°C to Peak Temperature	8 minutes max.



DISCLAIMER

CT MICRO RESERVES THE RIGHT TO MAKE CHANGES WITHOUT FURTHER NOTICE TO ANY PRODUCTS HEREIN TO IMPROVE RELIABILITY, FUNCTION OR DESIGN. CT MICRO DOES NOT ASSUME ANY LIABILITY ARISING OUT OF THE APPLICATION OR USE OF ANY PRODUCT OR CIRCUIT DESCRIBED HEREIN; NEITHER DOES IT CONVEY ANY LICENSE UNDER ITS PATENT RIGHTS, NOR THE RIGHTS OF OTHERS.

CT MICRO ARE NOT AUTHORIZED FOR USE AS CRITICAL COMPONENTS IN LIFE SUPPORT DEVICES OR SYSTEMS WITHOUT EXPRESS WRITTEN APPROVAL OF CT MICRO INTERNATIONAL CORPORATION.

- 1. Life support devices or systems are devices or systems which, (a) are intended for surgical implant into the body, or (b) support or sustain life, or (c) whose failure to perform when properly used in accordance with instruction for use provided in the labelling, can be reasonably expected to result in significant injury to the user.*
- 2. A critical component is any component of a life support device or system whose failure to perform can be reasonably expected to cause the failure of the life support device or system, or to affect its safety or effectiveness.*