



GRBP160406-PCSC3

Multi-Wavelength SMD Type

Features

- Side view 0602 package
- Wide viewing angle
- GRB individual control
- High reliability
- RoHS compliance

Applications

- General lighting
- Indoor signage display applications
- Switch light
- Decorative and Entertainment lighting

Description

The GRBP160406-PCSC3 is a high brightness device designed for demanding applications in efficiency and reduced space. An ideal device in emphasizing visual effects, advertisement, decoration as well as general backlighting needs.

Package Outline

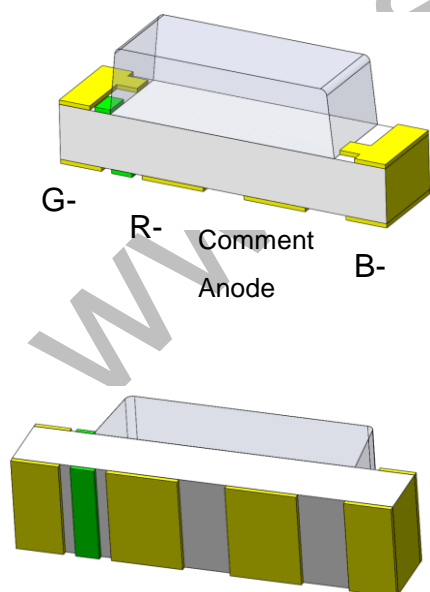

Schematic

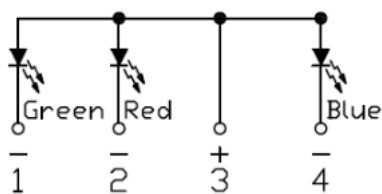



GRBP160406-PCSC3

Multi-Wavelength SMD Type

Absolute Maximum Rating at 25°C

Symbol	Parameters		Ratings	Units	Notes
I _F	Continuous Forward Current	G	20	mA	
		R	20		
		B	20		
I _{FP}	Peak Forward Current	G	60	mA	1
		R	60		
		B	60		
V _R	Reverse Voltage		10	V	
T _{opr}	Operating Temperature		-40 ~ +85	°C	
T _{stg}	Storage Temperature		-40 ~ +100	°C	
T _{sol}	Soldering Temperature		260	°C	2
P _D	Power Dissipation at(or below) 25°C Free Air Temperature	G	95	mW	
		R	60		
		B	95		

Electro-Optical Characteristics *T_A = 25°C (unless otherwise specified)*

Optical Characteristics (Green)

Symbol	Parameters	Test Conditions	Min	Typ	Max	Units	Notes
I _v	Luminous Intensity	I _F =5mA	90.0	-	225	mcd	3
λ _d	Dominant Wavelength	I _F =5mA	520	527	535	nm	4
θ _{1/2}	Angle of Half Intensity	I _F =5mA	-	±65	-	deg	

Electrical Characteristics (Green)

Symbol	Parameters	Test Conditions	Min	Typ	Max	Units	Notes
V _F	Forward Voltage	I _F =5mA	2.5	-	3.0	V	
I _R	Reverse Current	V _R =5V	-	-	1	μA	



GRBP160406-PCSC3

Multi-Wavelength SMD Type

Optical Characteristics (Red)

Symbol	Parameters	Test Conditions	Min	Typ	Max	Units	Notes
I _v	Luminous Intensity	I _F =5mA	14.5	-	36.0	mcd	3
λ _d	Dominant Wavelength	I _F =5mA	616	621	626	nm	
θ _{1/2}	Angle of Half Intensity	I _F =5mA	-	±65	-	deg	

Electrical Characteristics (Red)

Symbol	Parameters	Test Conditions	Min	Typ	Max	Units	Notes
V _F	Forward Voltage	I _F =5mA	1.6	-	2.1	V	
I _R	Reverse Current	V _R =5V	-	-	1	μA	

Optical Characteristics (Blue)

Symbol	Parameters	Test Conditions	Min	Typ	Max	Units	Notes
I _v	Luminous Intensity	I _F =5mA	22.5	-	57.0	mcd	3
λ _d	Dominant Wavelength	I _F =5mA	465	470	475	nm	4
θ _{1/2}	Angle of Half Intensity	I _F =5mA	-	±65	-	deg	

Electrical Characteristics (Blue)

Symbol	Parameters	Test Conditions	Min	Typ	Max	Units	Notes
V _F	Forward Voltage	I _F =5mA	2.6	-	3.1	V	
I _R	Reverse Current	V _R =5V	-	-	1	μA	

Notes:

1. I_{FP} Conditions--Pulse Width ≤ 100μs and Duty ≤ 10%.
2. Soldering time ≤ 10 seconds.



GRBP160406-PCSC3

Multi-Wavelength SMD Type

3. Bin Range of Luminous Intensity

Green				
Bin Code	Min	Max	Unit	Condition
QA	90	140	mcd	I _F =5mA
RA	140	225		
Red				
LA	14.5	22.5	mcd	I _F =5mA
MA	22.5	36.0		
Blue				
Bin Code	Min	Max	Unit	Condition
MA	22.5	36.0	mcd	I _F =5mA
NA	36.0	57.0		

Tolerance of Luminous Intensity $\pm 10\%$

4. Bin Range of Dominant Wavelength

Green				
Bin Code	Min	Max	Unit	Condition
A5	520	525	nm	I _F =5mA
A6	525	530		
A7	530	535		
Blue				
A6	465	470	nm	I _F =5mA
A7	470	475		

Tolerance of Dominant Wavelength: $\pm 1\text{nm}$.



Typical Characteristic Curves

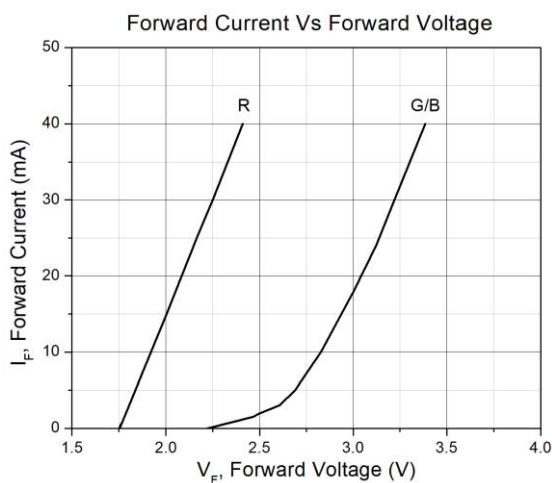

Figure 1

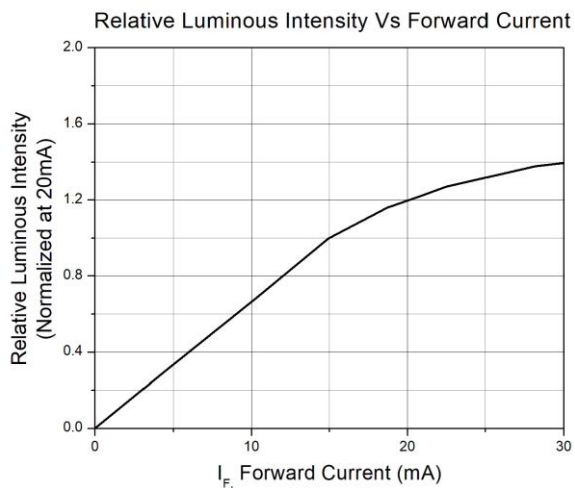

Figure 2

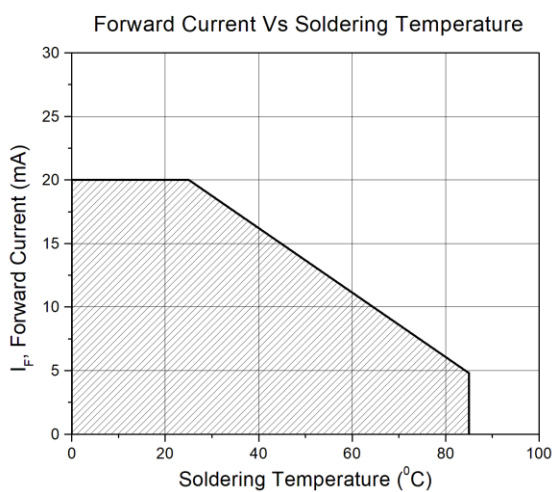

Figure 3

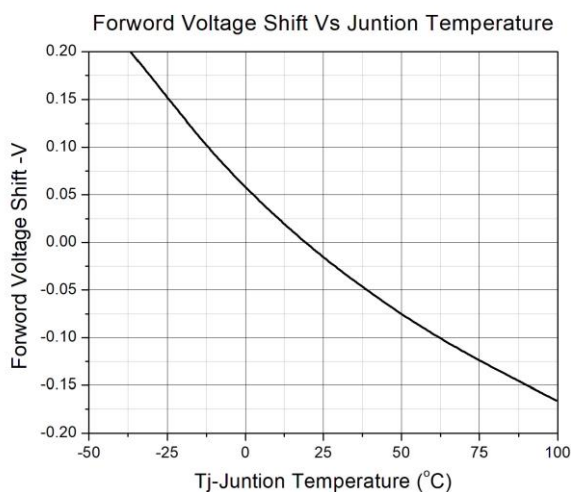

Figure 4

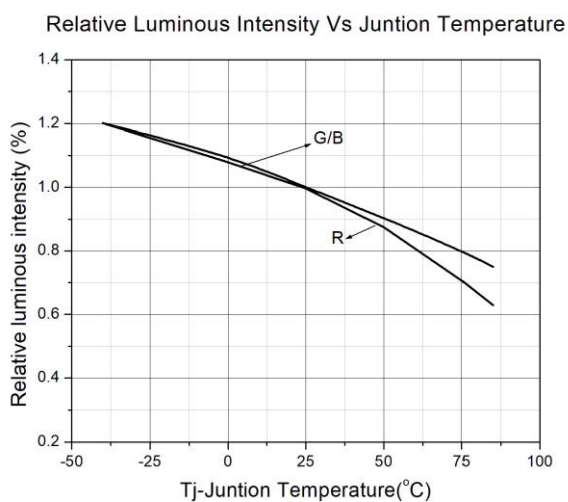

Figure 5

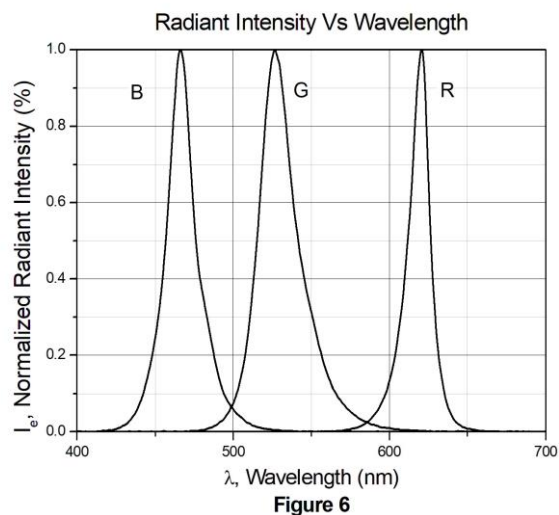

Figure 6



Typical Characteristic Curves

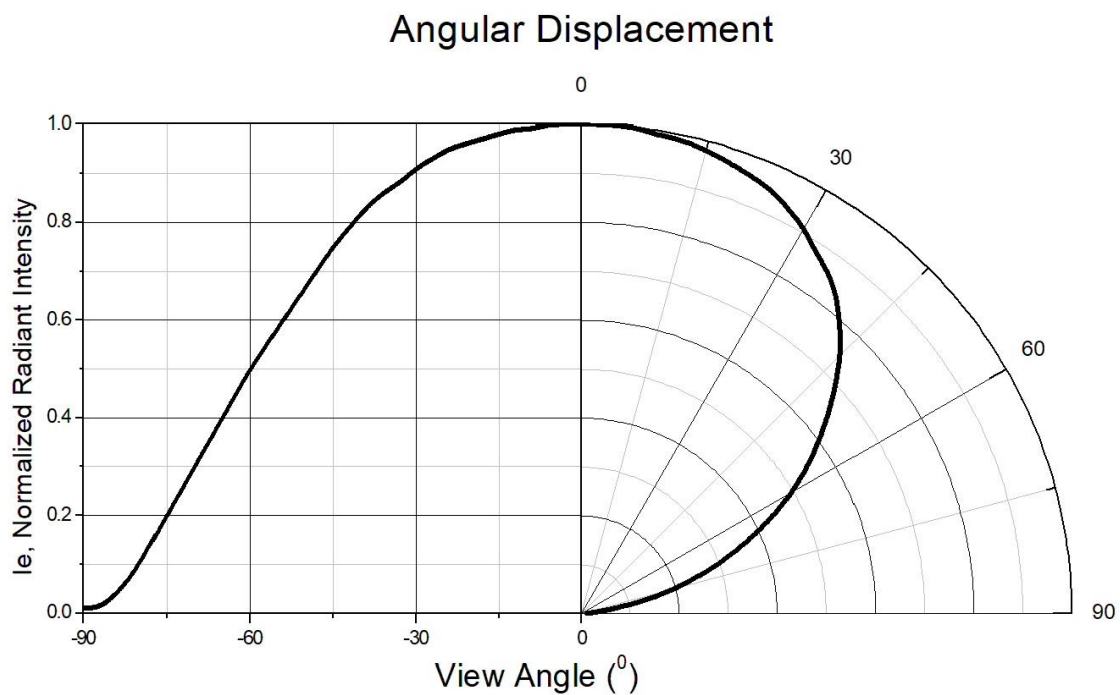

Figure 7

www.sig



GRBP160406-PCSC3

Multi-Wavelength SMD Type

Package Dimension *All dimensions are in mm, unless otherwise stated*

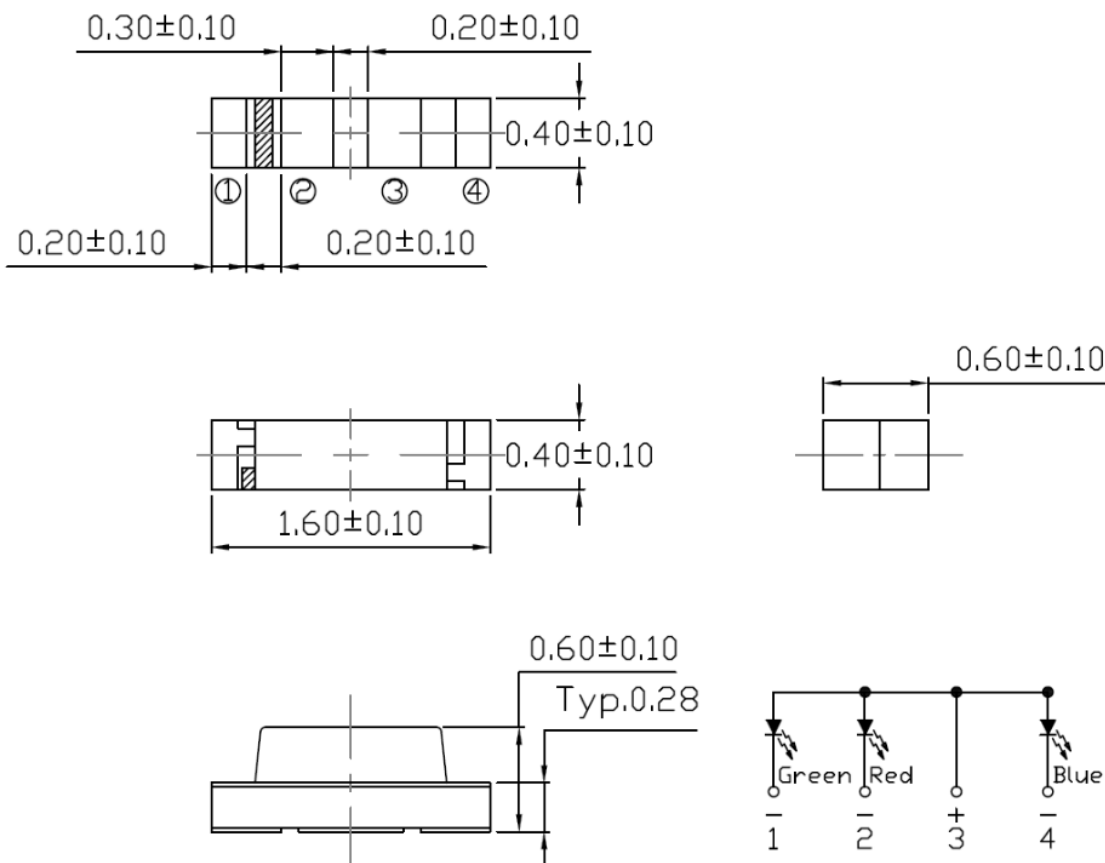

Note: Tolerance unless mentioned is $\pm 0.1\text{mm}$

Recommended Soldering Mask *All dimensions are in mm, unless otherwise stated*

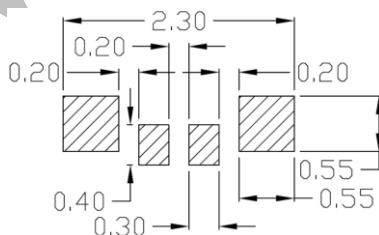

Note: Tolerance unless mentioned is $\pm 0.1\text{mm}$

Ordering Information

Part Number	Description	Quantity
GRBP160406-PCSC3	Tape & Reel	3000 pcs



GRBP160406-PCSC3

Multi-Wavelength SMD Type

Reel Dimension

All dimensions are in mm, unless otherwise stated

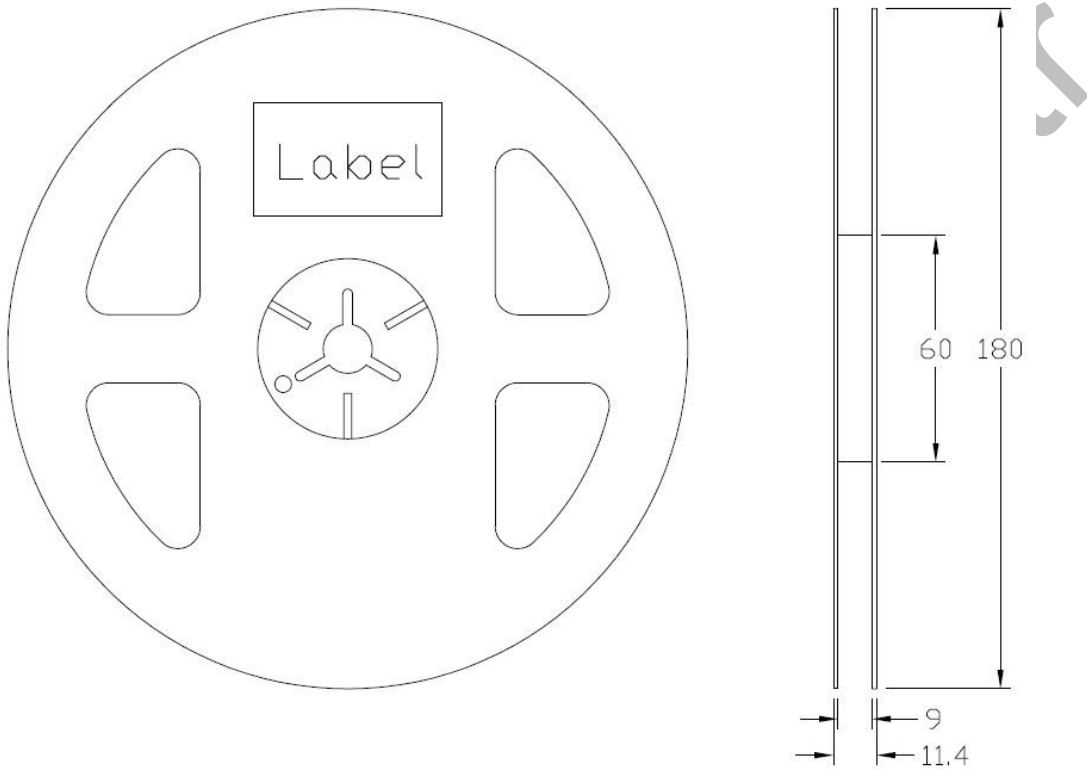

Tape Dimension

All dimensions are in mm, unless otherwise stated

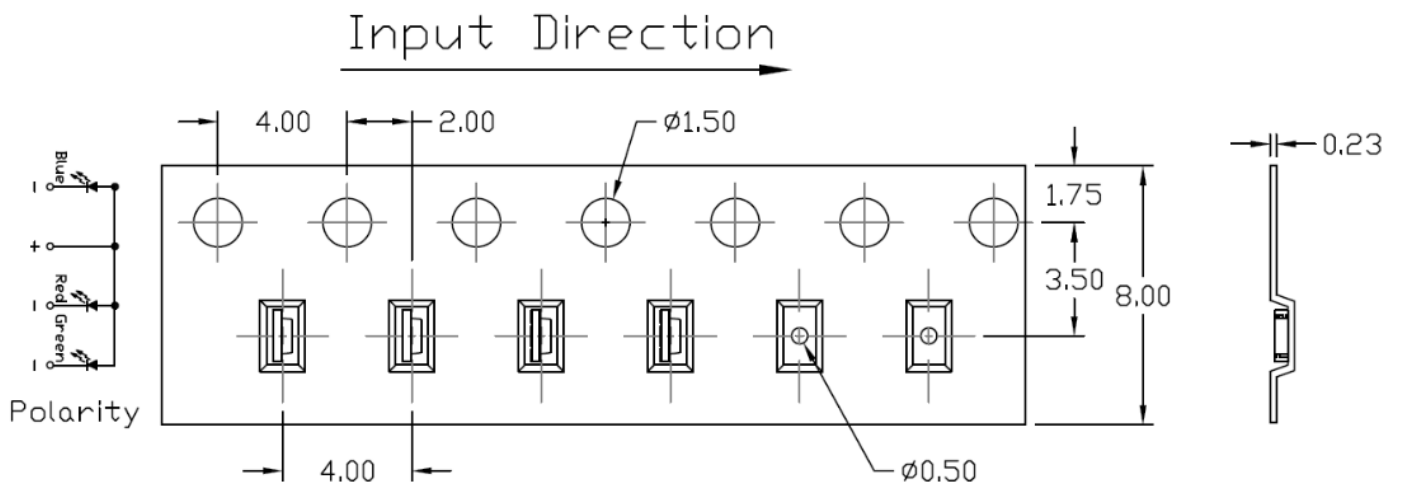

Note: Tolerance unless mentioned is ± 0.1 mm



Label Form Specification

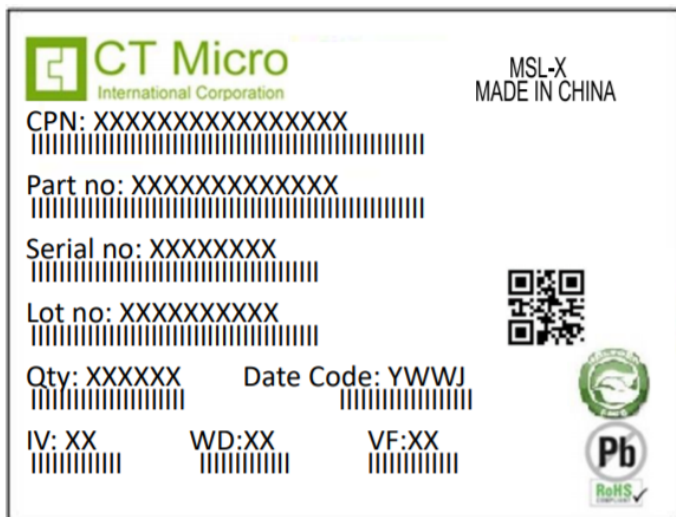

CPN : Customer Part Number
 Part no: CTM Production Number
 Serial no: Production Number
 Lot no: Lot number
 Q'ty: Packing Quantity
 Date Code: Manufacture Date
 IV : Bin Code of Luminous Intensity
 WD : Bin Code of Dominant Wavelength
 VF : Bin Code of Forward Voltage
 MADE IN CHINA: Production Place

Storage Condition

1. Do not open moisture proof bag before the products are ready to use.
2. The moisture barrier bag should be stored at 30°C and 90%R.H. max. before opening.
Shelf life of non-opened bag is 12 months after the bag sealing date.
3. After opening the moisture barrier bag floor life is 1 year at 30°C/60%RH. max. Unused LEDs should be resealed into moisture barrier bag. (Refer to J-STD-020 Standard)
4. If the moisture absorbent material has faded away or the LEDs have exceeded the storage time, baking treatment should be performed using the J-STD-033 Standard conditions.



Reflow Profile

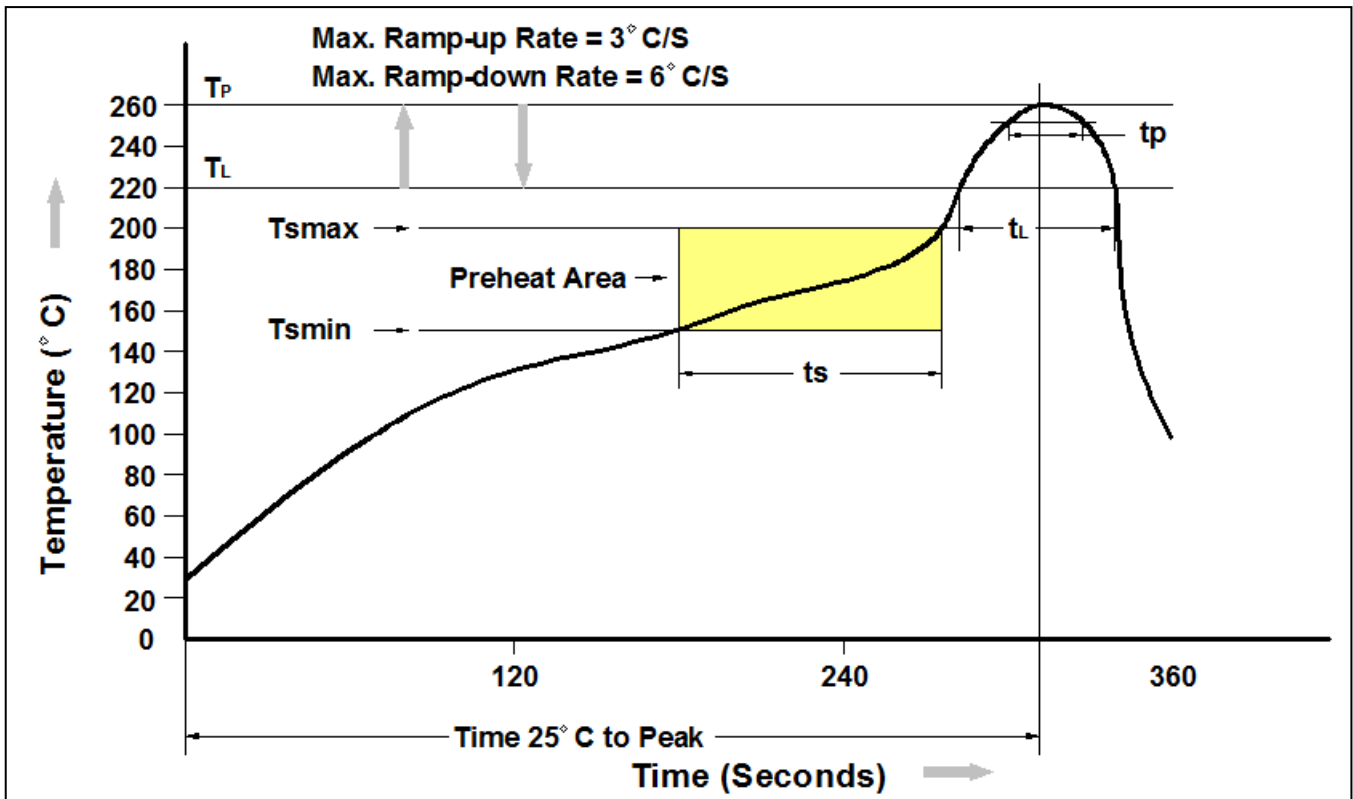

Profile Feature	Pb-Free Assembly Profile
Temperature Min. (T_{smin})	150°C
Temperature Max. (T_{smax})	200°C
Time (t_s) from (T_{smin} to T_{smax})	60-120 seconds
Ramp-up Rate (t_L to t_P)	3°C/second max.
Liquidous Temperature (T_L)	217°C
Time (t_L) Maintained Above (T_L)	60 – 150 seconds
Peak Body Package Temperature	260°C +0°C / -5°C
Time (t_P) within 5°C of 260°C	30 seconds
Ramp-down Rate (T_P to T_L)	6°C/second max
Time 25°C to Peak Temperature	8 minutes max.



DISCLAIMER

CT MICRO RESERVES THE RIGHT TO MAKE CHANGES WITHOUT FURTHER NOTICE TO ANY PRODUCTS HEREIN TO IMPROVE RELIABILITY, FUNCTION OR DESIGN. CT MICRO DOES NOT ASSUME ANY LIABILITY ARISING OUT OF THE APPLICATION OR USE OF ANY PRODUCT OR CIRCUIT DESCRIBED HEREIN; NEITHER DOES IT CONVEY ANY LICENSE UNDER ITS PATENT RIGHTS, NOR THE RIGHTS OF OTHERS.

CT MICRO ARE NOT AUTHORIZED FOR USE AS CRITICAL COMPONENTS IN LIFE SUPPORT DEVICES OR SYSTEMS WITHOUT EXPRESS WRITTEN APPROVAL OF CT MICRO INTERNATIONAL CORPORATION.

- 1. Life support devices or systems are devices or systems which, (a) are intended for surgical implant into the body, or (b) support or sustain life, or (c) whose failure to perform when properly used in accordance with instruction for use provided in the labelling, can be reasonably expected to result in significant injury to the user.*
- 2. A critical component is any component of a life support device or system whose failure to perform can be reasonably expected to cause the failure of the life support device or system, or to affect its safety or effectiveness.*