

SCSI Centronic IDC Type With Hood

Specifications

Current Rate: 1 AMP
 Insulation Resistance: 500MΩ Min.
 Contact Resistance: 35mΩ Max.
 Dielectric Voltage: 500V AC for one minute
 Operation Temperature: -55°C to +105°C

Material

Insulator: Polyester, UL 94V-0
 ©Standard: PBT
 Terminal: Copper Alloy

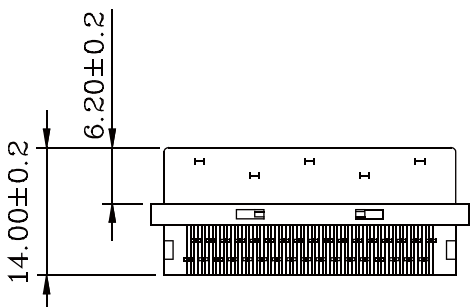
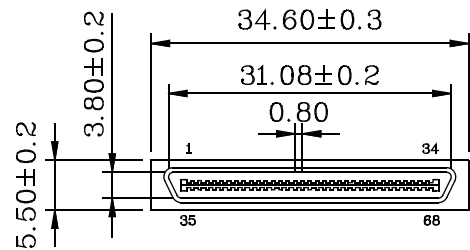
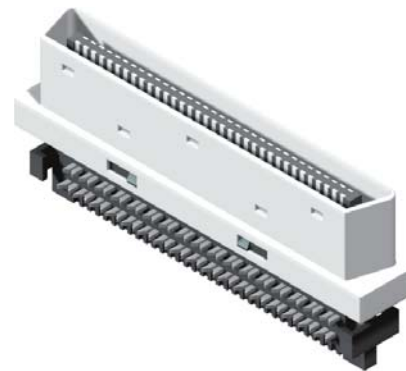

Termination Cover
(2 Places)

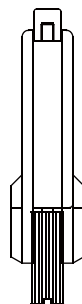
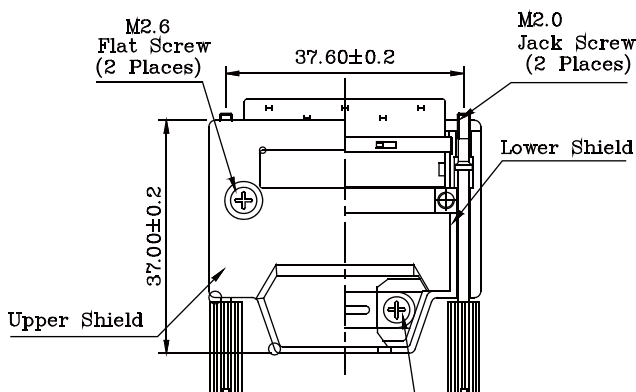
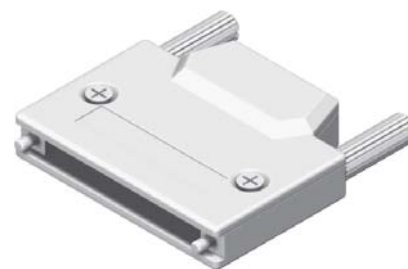
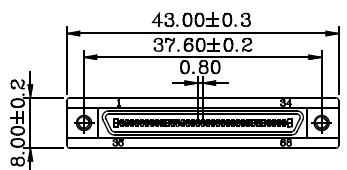
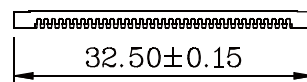
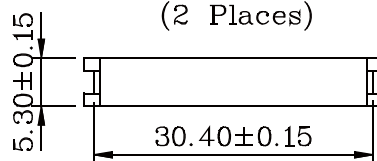

Hood Table

Type	Wire Holder	Entry Hold Size
1	0.61	∅0.90
2	0.68	∅0.90

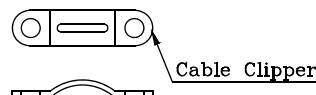
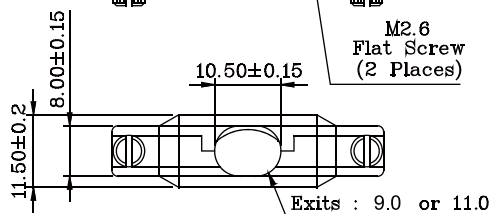

Order Information

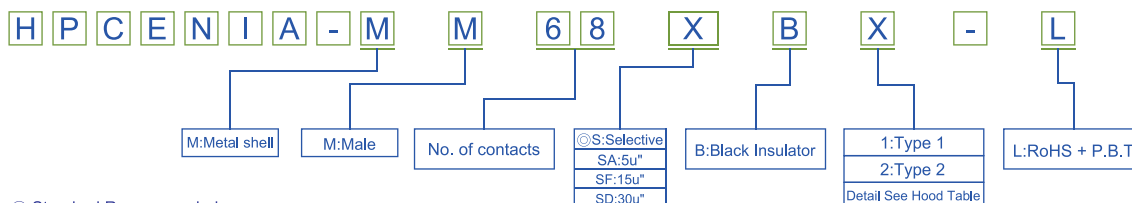

©: Standard Recommended