

W7500S2E module series support both data pass-through mode and AT data transfer mode. It supports TCP server, TCP clients and UDP 3 operation mode. Serial baud rate can be as high as 460,800bps. It can be configured by PC configuration utility, web page and AT command. The unparalleled and robust of W7500S2E module based on ARM Cortex 32bit MCU with hardwired TCP/IP. Accompanied by a vast functionalities, makes the family of products the ideal choice, both for new design project or an upgrading of current platform.

Features

- Support dual mode: "Data pass-through" and "AT data transfer"
- Support TCP server, TCP client and UDP operating modes
- Support RS-485 enable pin of an external RS-485 transceiver
- Flexible data packet condition for the serial interface
- Support DHCP to configure IP address and other network configuration parameters
- Support DNS for remote server domain name lookup
- Support NetBIOS for easy access of web configuration page
- Support three configuration method: serial AT command, PC software and web page
- Support local firmware upgrade by PC software
- Support "Keep-Alive" to guarantee TCP connection

Specification

- 10/100Mbps Ethernet interface
- Serial interface: 3.3V TTL: TXD, RXD, CTS, RTS, GND
 - Baud Rate: From 300bps to 460,800bps with 16 common values
 - Data Bit: 7, 8
 - Stop Bit: 1, 2
 - Parity: NONE, EVEN, ODD
 - Flow Control: NONE, CTS/RTS
- Power supply:
 - W7500S2E-Z1: DC 5.0V
 - W7500S2E-R1: DC 3.3V
 - W7500S2E-S1: DC 3.3V
- Dimension: L×W×H (mm)
 - W7500S2E-Z1: 44.45×31.75×15.75
 - W7500S2E-R1: 44.45×31.75×23.00
 - W7500S2E-S1: 34.00×24.00×12.40
- Operating temperature:
 - W7500S2E-Z1: -40°C ~ +85°C
 - W7500S2E-R1: -40°C ~ +85°C
 - W7500S2E-S1: -40°C ~ +85°C
- Storage environment:
 - W7500S2E-Z1: -50°C~ +95°C, 5 ~ 95% RH
 - W7500S2E-R1: -50°C~ +95°C, 5 ~ 95% RH
 - W7500S2E-S1: -50°C~ +95°C, 5 ~ 95% RH

Document Revision History

Version	Date	Remarks
V1.0	2018/10/10	Initial release
V1.0.1	2019/01/30	Enhance the description of AT command section Correct modes information in [Operating Mode (C1_OP)] Revise Figure 3-1, 3-2 and 3-3 Revised structure of documentation
V1.1	2019/02/19	Add new "Data transfer command" Revised structure of documentation Remove obsolete information Updated all images
V1.1.1	2019/03/19	Move "Factory reset" to an individual chapter 8 Move "Firmware upgrade" to an individual chapter 9 Add notes for firmware version 2.2
V1.2	2022/01/29	Added "W7500S2E-S1" related content Added 2.54mm Pin Header dimension

Copyright notice

Copyright © WIZnet H.K. Ltd. All rights reserved.

Contact E-mail: supports@wiznet.hk

For more information, please visit: <https://www.wizse.com/>

Table of Contents

1	Introduction.....	1
1.1	Overview.....	1
1.2	Specifications.....	1
2	Hardware description	6
2.1	Pin definition.....	6
2.2	WIZS2E breakout board.....	8
2.3	Quick testing guide.....	12
3	Operating modes	13
3.1	TCP server mode.....	13
3.2	TCP client mode.....	13
3.3	UDP mode.....	13
4	Data transfer mode.....	14
4.1	Data pass-through mode	14
4.2	AT data transfer mode.....	14
4.3	How to enter "Data pass-through mode"	15
5	WIZS2E ConfigTool	15
5.1	Reading module information.....	15
5.2	Modify the device settings.....	16
5.3	Reset the module.....	16
5.4	Useful features.....	16
6	Introduction of AT command	18
6.1	AT command overview.....	18
6.2	AT command responds	18
6.3	Entering AT command Mode	19
6.4	AT command list	19
6.5	AT command details	23
6.6	AT Data transfer command	38
6.7	AT command script examples.....	42
7	Web configuration	44
7.1	Login page	44
7.2	Basic Settings	45
7.3	Advance Options	46
7.4	Management.....	48
8	Factory reset.....	49
8.1	By ConfigTool.....	49
8.2	By using AT command	49
8.3	By hardware	49
9	Firmware upgrade	50
	Disclaimers	51





1 Introduction

1.1 Overview

W7500S2E series modules have the following different part numbers which depend on different footprint and connectors.

There are different pin assignments for the modules, please see 2.1 for details

Table 1-1 W7500S2E type comparison

Part number	Outlook	Features
W7500S2E-S1		<ol style="list-style-type: none"> 1. Dimension: 34.00x24.00x12.40 (mm) 2. Network interface type: Ethernet transformer 3. Voltage input DC 3.3V 4. Operating temperature: -40°C ~ +85°C
W7500S2E-Z1		<ol style="list-style-type: none"> 1. Dimension: 44.45x31.75x15.75 (mm) 2. Network interface type: Ethernet transformer 3. Voltage input DC 5.0V 4. Operating temperature: -40°C ~ +85°C
W7500S2E-R1		<ol style="list-style-type: none"> 1. Dimension: 44.45x31.75x23.00 (mm) 2. Network interface type: RJ45 3. Voltage input DC 3.3V 4. Operating temperature: -40°C ~ +85°C
W7500S2E-C1		<ol style="list-style-type: none"> 1. W7500 MCU integrated with W7500S2E firmware 2. Operating temperature: -40°C ~ +85°C 3. For hardware details, please visit the W7500 web site

Configuration methods

W7500S2E provides three configuration methods:

- User can configure the module by the WIZS2E ConfigTool utility, which is software running in Windows® environment. For details, please refer to chapter 4.
- Main MCU can send AT command through serial port for parameter configuration or user can send the AT command through serial port by a serial terminal software. For details, please refer to chapter 6.
- Web page configuration allows user to configure the module through web browsers in the same local area network. For details, please refer to chapter 7.

1.2 Specifications

Electrical characteristics

Voltage and current characteristics

The following tables show the voltage and current under 25°C environment

Table 1-2 W7500S2E-R1 & W7500S2E-S1 electrical characteristics ($V_{IN}=3.3V$)

Symbol	Types	Ratings			
		Min	Typical	Max	Unit
V_{DD}	Module voltage	3.0	3.3	3.6	V
I	Module current	73	66	61	mA

Table 1-3 W7500S2E-Z1 electrical characteristics ($V_{IN}=5.0V$)

Symbol	Types	Ratings			
		Min	Typical	Max	Unit
V_{IN}	Module voltage	4.4	5.0	6.0	V
I_{IN}	Module current	75	66	55	mA

Current characteristics

Table 1-4 W7500S2E-R1 & W7500S2E-Z1 & W7500S2E-S1 Current characteristics

Working Mode	Ratings (mA)
Standby	53
Normal communication	66

Dimension

Please refer to the figure below which shows the dimension of the module.

W7500S2E-Z1 layout and dimension

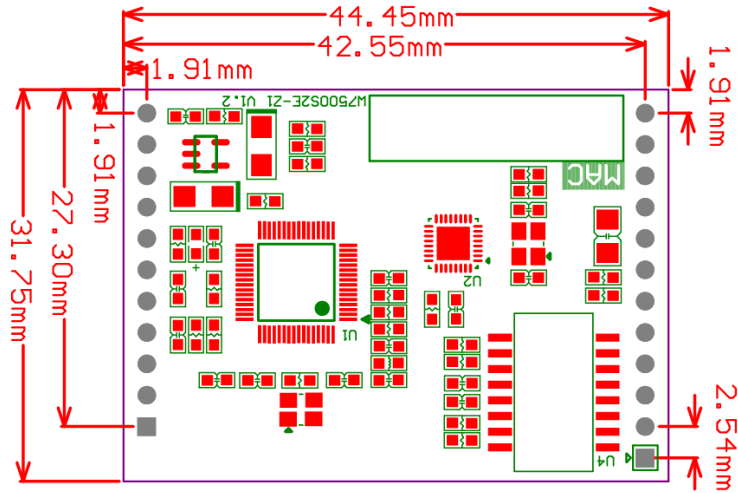

Figure 1-1 W7500S2E-Z1 dimension - top view

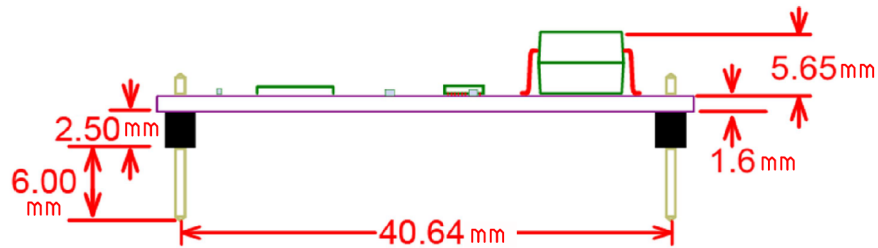

Figure 1-2 W7500S2E-Z1 dimension - side view

A power LED locates on the top of each module with a small + sign marking above.

W7500S2E-R1 layout and dimension

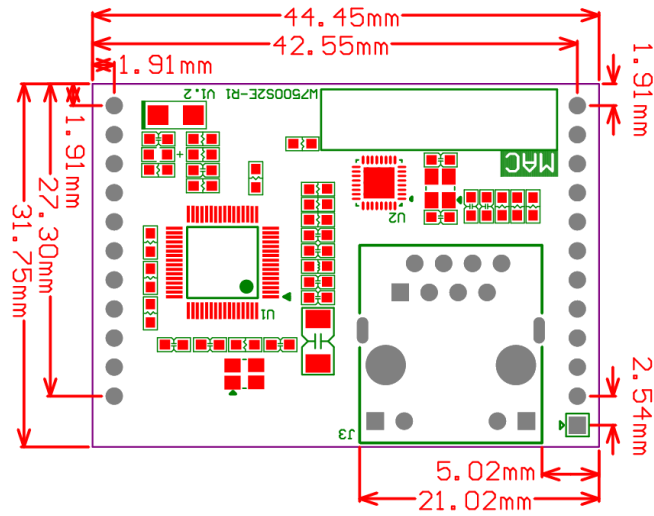

Figure 1-3 W7500S2E-R1 dimension - top view

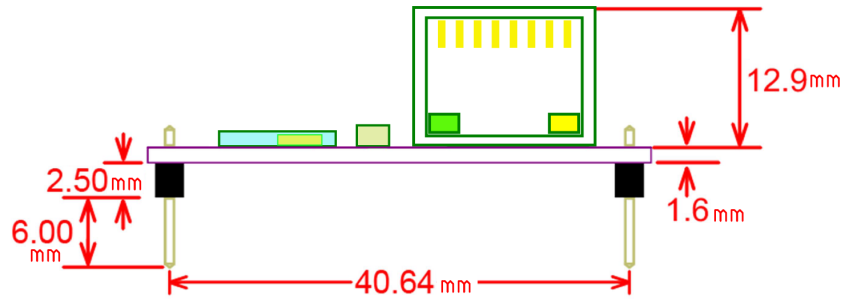

Figure 1-4 W7500S2E-R1 dimension - side view

A power LED locates on the top of each module with a small + sign marking above.

W7500S2E-S1 layout and dimension

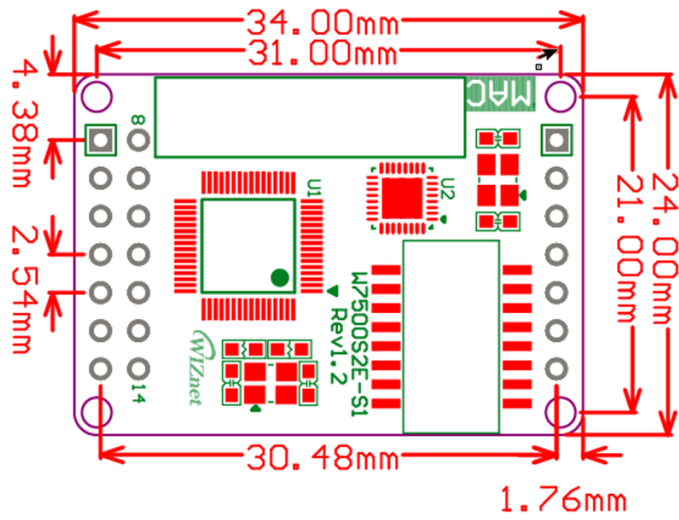

Figure 1-5 W7500S2E-S1 dimension - top view

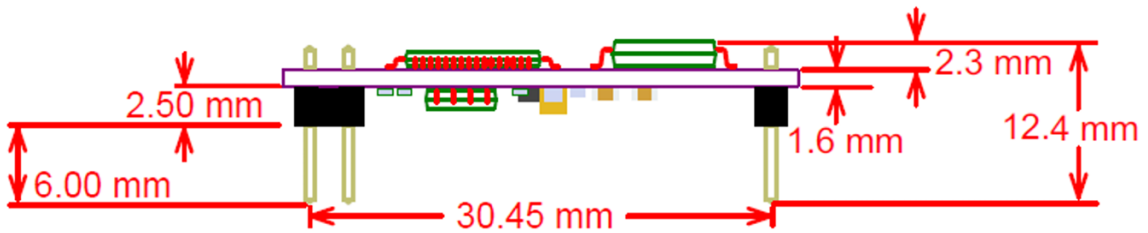

Figure 1-6 W7500S2E-S1 dimension - side view

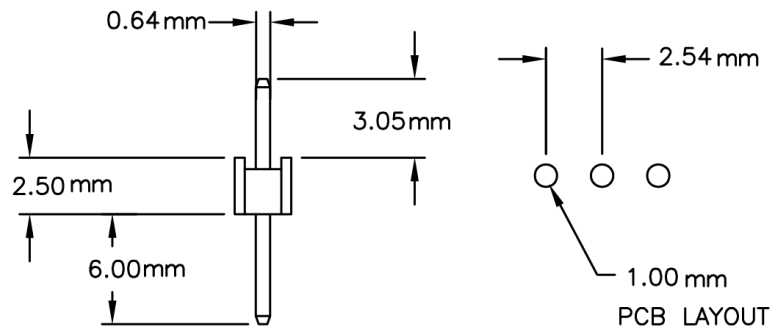

Figure 1-7 2.54mm Pin Header dimension

2 Hardware description

2.1 Pin definition

2.1.1 W7500S2E-Z1 pinout and pin definition

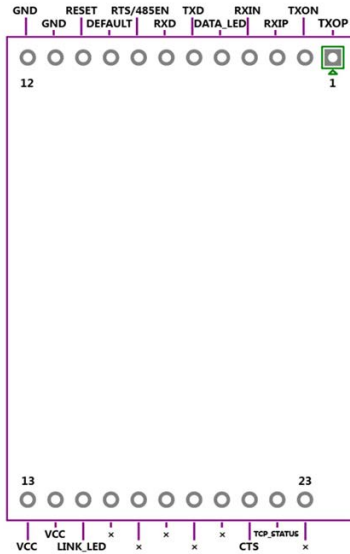

Figure 2-1 W7500S2E-Z1 pinout

Table 2-1 W7500S2E-Z1 pin definition

Pin no.	Pin Name	I/O	Description
1	TXOP	O	Ethernet TXOP signal
2	TXON	O	Ethernet TXON signal
3	RXIP	I	Ethernet RXIP signal
4	RXIN	I	Ethernet RXIN signal
5	DATA_LED	O	Ethernet & serial status indicator Change status while data channel changes
6	TXD	O	UART TXD signal
7	RXD	I	UART RXD signal
8	RTS	O	UART flow control RTS signal
	485EN	O	Configurable as 485 enable pin (This function is supported by firmware version is 2.2 or above)
9	DEFAULT	I	Factory reset pin (pull down over 3s)
10	RESET	I	Reset pin (pull down over 200ms)
11	GND	-	Ground
12	GND	-	Ground
13	VCC	-	DC 5.0V
14	VCC	-	DC 5.0V
15	LINK_LED	O	Ethernet link indicator
16	x	-	-
17	x	-	-
18	x	-	-
19	x	-	-
20	x	-	-
21	CTS	I	UART flow control CTS signal pin
22	TCP_STATUS	O	TCP connection status indicator High: TCP connection Close Low: TCP connection Establish (This function is supported by firmware version is 2.2 or above)
23	x	-	-

2.1.2 W7500S2E-R1 pinout and pin definition



Figure 2-2 W7500S2E-R1 pinout

Table 2-2 W7500S2E-R1 pin definition

Pin No.	Pin Name	I/O	Function
1	x	-	-
2	x	-	-
3	x	-	-
4	x	-	-
5	DATA_LED	O	Ethernet & serial status indicator Change status while data channel changes
6	TXD	O	UART TXD signal
7	RXD	I	UART RXD signal
8	RTS	O	UART flow control RTS signal
	485EN	O	Configurable as 485 enable pin (This function is supported by firmware version is 2.2 or above)
9	DEFAULT	I	Factory reset pin (pull down over 3s)
10	RESET	I	Reset pin (pull down over 200ms)
11	GND	-	Ground
12	GND	-	Ground
13	VCC	-	DC 3.3V
14	VCC	-	DC 3.3V
15	LINK_LED	O	Ethernet link indicator
16	x	-	-
17	x	-	-
18	x	-	-
19	x	-	-
20	x	-	-
21	CTS	I	UART flow control CTS signal pin
22	TCP_STATUS	O	TCP connection status indicator High: TCP connection Close Low: TCP connection Establish (This function is supported by firmware version is 2.2 or above)
23	x	--	--

2.1.3 W7500S2E-S1 pinout and pin definition

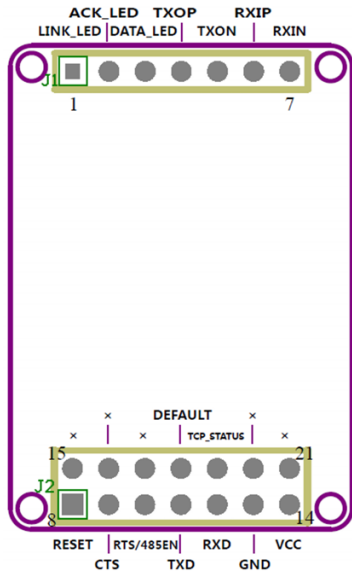

Figure 2-3 W7500S2E-S1 pinout

Table 2-3 W7500S2E-S1 pin definition

Pin No.	Pin Name	I/O	Function
1	LINK_LED	O	Ethernet link indicator
2	ACT_LED	O	
3	DATA_LED	O	Ethernet & serial status indicator Change status while data channel changes
4	TXOP	O	Ethernet TXOP signal
5	TXON	O	Ethernet TXON signal
6	RXIP	I	Ethernet RXIP signal
7	RXIN	I	Ethernet RXIN signal
8	RESET	I	Reset pin (pull down over 200ms)
9	CTS	I	UART flow control CTS signal pin
10	RTS	O	UART flow control RTS signal
	485EN	O	Configurable as 485 enable pin (This function is supported by firmware version is 2.2 or above)
11	TXD	O	UART TXD signal
12	RXD	I	UART RXD signal
13	GND	-	Ground
14	VCC	-	DC 3.3V
15	x	-	-
16	x	-	-
17	x	-	-
18	DEFAULT	I	Factory reset pin (pull down over 3s)
19	TCP_STATUS	O	TCP connection status indicator High: TCP connection Close Low: TCP connection Establish (This function is supported by firmware version is 2.2 or above)
20	x	-	-
21	x	-	-

2.2 WIZS2E breakout board

The WIZS2E-EVB evaluation board provides a simple and speedy connection for evaluating the W7500S2E-Z1 and the W7500S2E-R1. The connectors and I/O are shown below.

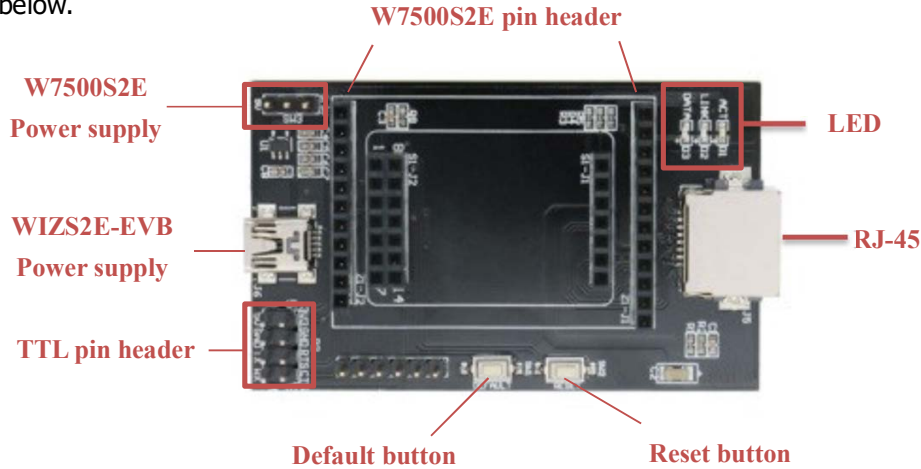
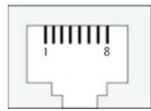

Figure 2-4 WIZS2E breakout board

WIZS2E-EVB evaluation board integrates RJ45, UART (TTL) and mini USB interfaces.

- ◆ RJ45 (J5) interface pin assignment

"x" indicate for not connected



Pin	Signal	Pin	Signal
1	RXIN	5	×
2	RXIP	6	TXOP
3	TXON	7	×
4	×	8	×

- ◆ P2 interface pin Assignment

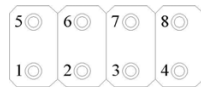

Pin	Signal	Pin	Signal
1	5V	5	3V3
2	GND	6	GND
3	TX	7	RTS
4	RX	8	CTS

- ◆ The mini USB Interface (J6) pin assignment

Note: This mini USB connector is only for the power supply 5V DC of the evaluation board.

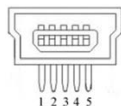

Pin	Signal	Pin	Signal
1	5.0V	4	×
2	×	5	GND
3	×	7	RTS

- ◆ SW3 is power supply selection jumper for 5V or 3.3V; please short the corresponding voltage to the Vcc pin.

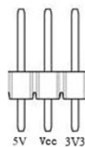

Pin	Signal	Description
5V	5.0V	Short with Vcc for W5500S2E-Z1
Vcc	Vcc	Short with 5V or 3V3 for Vcc voltage-
3V3	3.3V	Short with Vcc for W5500S2E-R1

◆ WIZSE evaluation board button description

Table 2-4 WIZS2E breakout board button description

Button	Description
SW1 (default)	Press button over 3 seconds for factory reset
SW2 (RESET)	Hardware reset button

◆ WIZS2E breakout board LED description

Table 2-5 WIZS2E breakout board LED description

LED	Description
ACT	Ethernet ACT indicator
LINK	Ethernet LINK indicator
DATA	Ethernet & serial status indicator Change status while data channel changes

1. W7500S2E-Z1 reference schematic

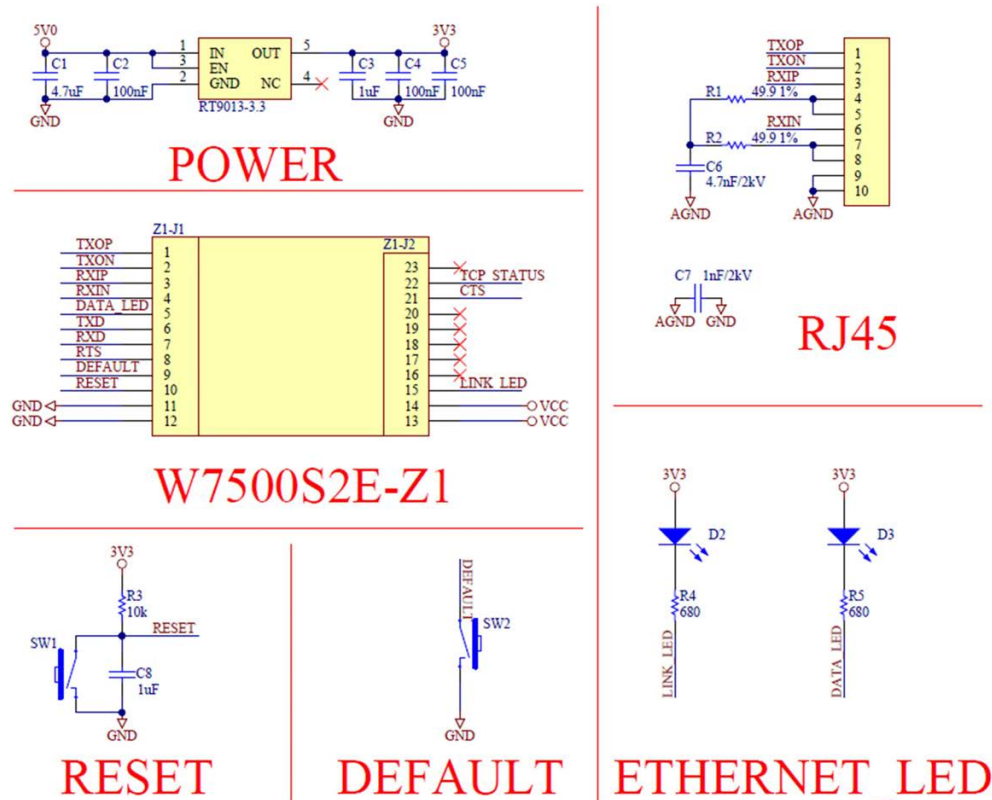

Figure 2-4 W7500S2E-Z1 reference schematic

2. W7500S2E-R1 reference schematic

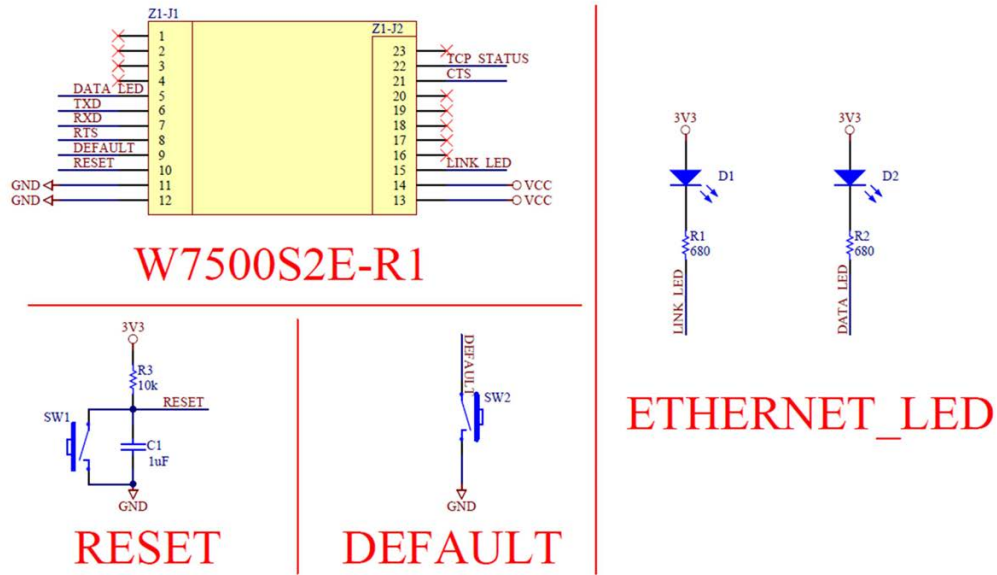

Figure 2-5 W7500S2E-R1 reference schematic

3. W7500S2E-S1 reference schematic

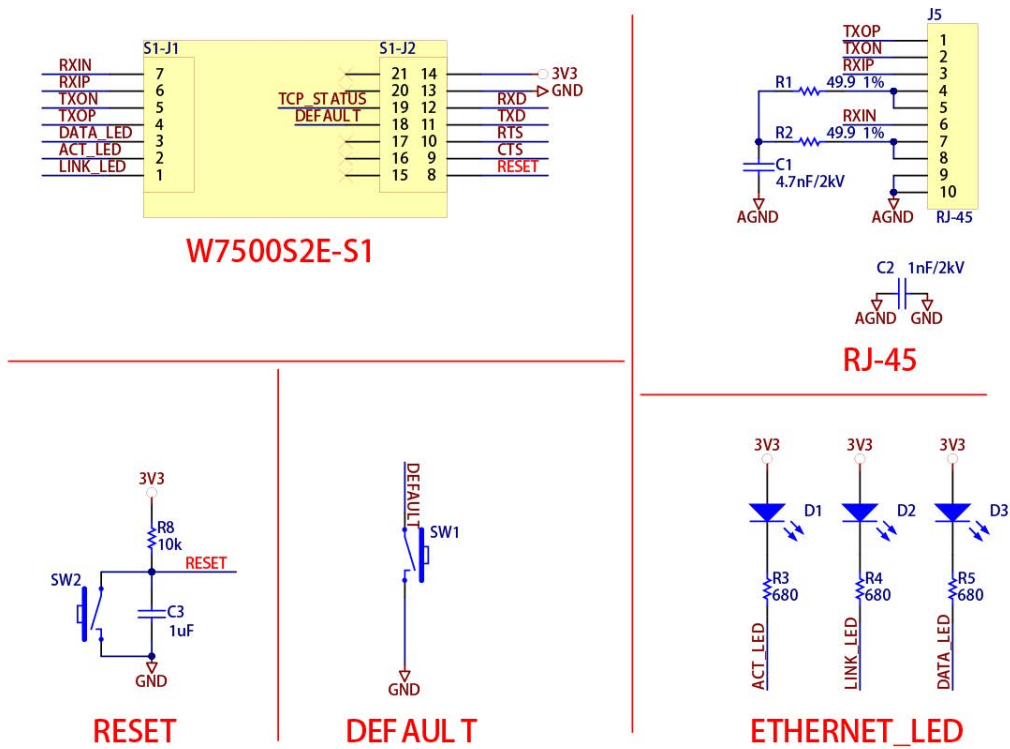

Figure 2-6 W7500S2E-S1 reference schematic

2.3 Quick testing guide

WIZS2E module can convert any devices with serial interface to have Ethernet connectivity easily.

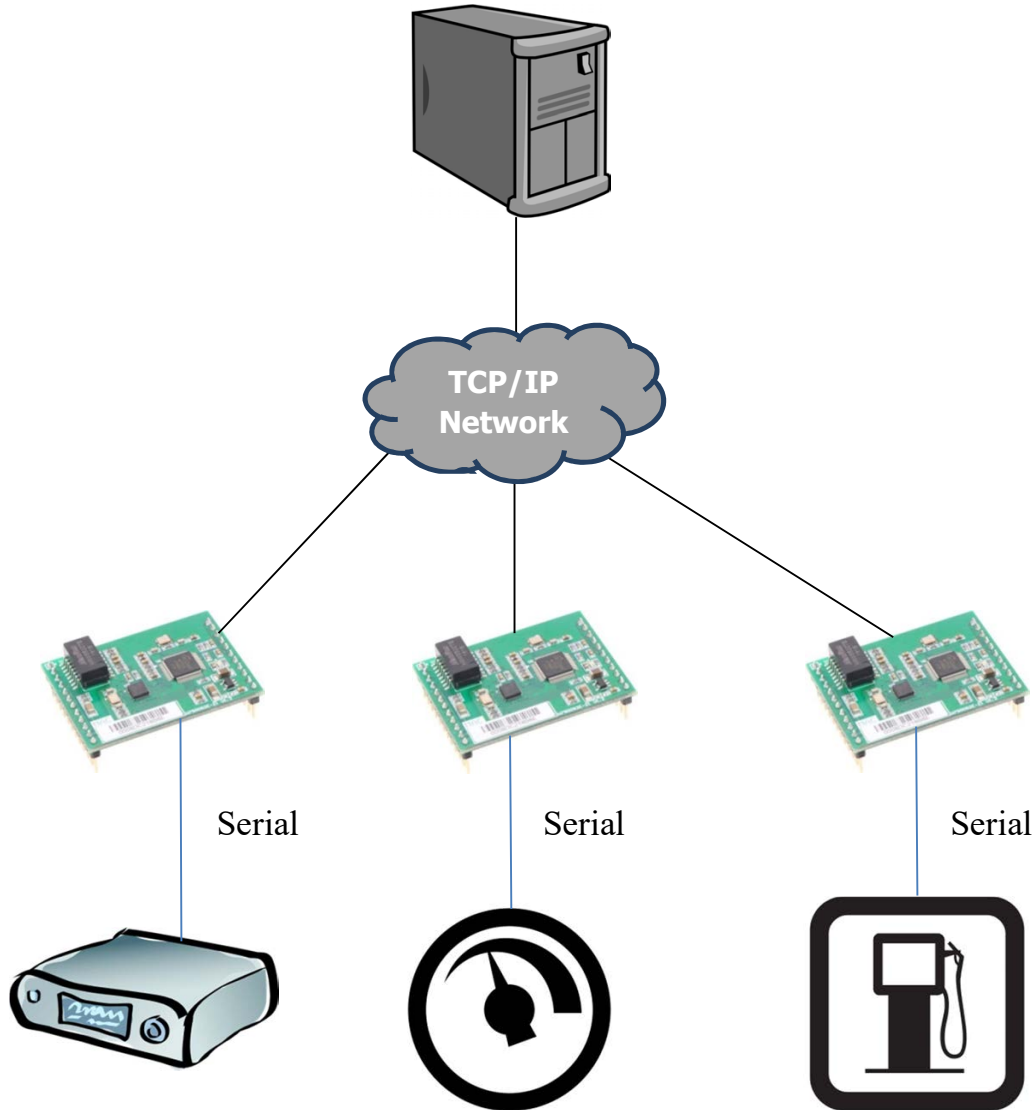

Figure 2-6 W7500S2E module testing evaluation block diagram

3 Operating modes

W7500S2E module supports TCP server, TCP client and UDP modes. The followings demonstrate these operating modes.

3.1 TCP server mode

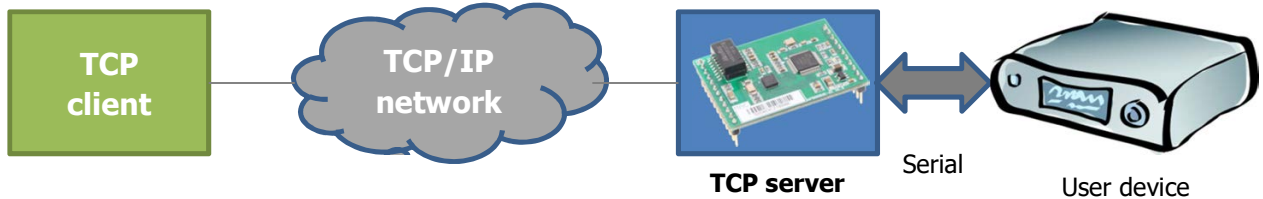
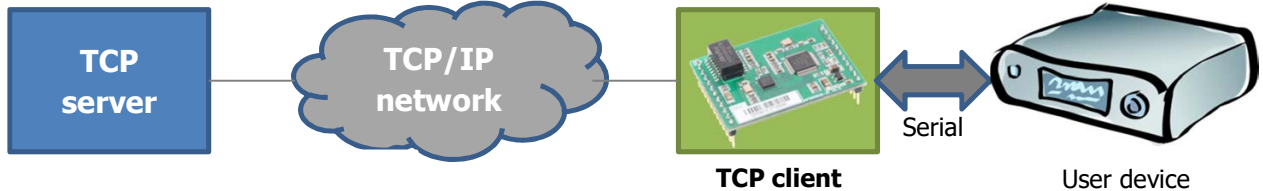

Figure 3-1 TCP server mode diagram

In TCP server mode, W7500S2E listens on a local port and waiting for the connection from a TCP client. They can start communication each other after link established.

3.2 TCP client mode

Figure 3-2 TCP client mode diagram



In TCP client mode, W7500S2E connects to a preset TCP server. If failure to connect, it can be configured to re-connect continuously. They can start communication each other after link established.

3.3 UDP mode

Figure 3-3 UDP mode diagram

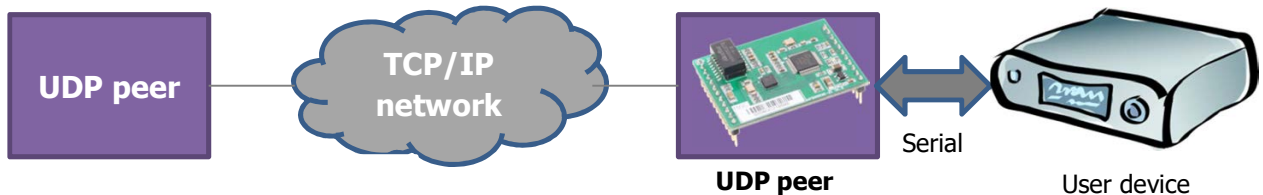

In UDP mode, W7500S2E acts as an UDP peer to send data to another preset UDP peer. W7500S2E can also receive data from other UDP peers.

4 Data transfer mode

W7500S2E series serial-to-Ethernet module has two mode of data transfer mode to choose from. It includes "Data pass-through mode" & "AT data transfer mode". Whereas "AT data transfer mode" is supported by firmware version 2.2 and above

4.1 Data pass-through mode

Data pass-through mode of W7500S2E has the following characteristics

1. To configure W7500S2E to transmit data, parameters need to be configured in AT command before switching into "data pass-through mode"
2. Module will enter the preset mode and parameter after module entered into "data pass-through mode"
 - ① In TCP server mode, it will listen on a local port and wait for a TCP client connection
 - ② In TCP client mode, it will connect to the preset remote TCP server until connection establish
 - ③ In UDP mode, no connection is needed. Module will wait for the data
3. After establish TCP connection or entered UDP mode, data will be pass-through between the serial and Ethernet ports according to the preset settings
4. If the TCP connection is closed, module will act as below
 - ① In TCP server mode, it will listen on a local port again and wait for a TCP client connection
 - ② In TCP client mode, it will reconnect to the preset remote TCP server
5. If the MCU would like to change the parameters. It is need to exit the "data pass-through mode" and enter into AT command mode for configure the parameters

4.2 AT data transfer mode

AT data transfer mode of W7500S2E has the following characteristics

1. To configure W7500S2E to transmit data, parameters can be configured in AT command mode. Sending data in "AT data transfer mode" does not require switching mode
2. After configure the parameter, data can be send directly in AT command mode for TCP or UDP communication
 - ① In TCP server mode, it will listen on a local port and wait for a TCP client connection
 - ② In TCP client mode, it will connect to the preset remote TCP server. If connection cannot be establish within 3s. It is need to resend command to reconnect.
 - ③ In UDP mode, no connection is needed. Module will wait for the data
3. After establish TCP connection or entered UDP mode, data can be sent or received for single packet at a time only
4. If TCP connection is close. It is need to reconnected using AT command.

5. If parameters changes are needed, it can be configured directly using AT command.

4.3 How to enter “Data pass-through mode”

There is three ways for entering the “data pass-through mode”.

- 1 By AT command (For details, please refer to chapter 6 “RESET & “EXIT” command)
- 2 Web page (For details, please refer to chapter 7)
- 3 WIZS2E ConfigTool utility (For details, please refer to chapter 5)

5 WIZS2E ConfigTool

WIZS2E ConfigTool is Windows® software compatibles to all WIZS2E modules. It can be used to read, configure all settings and firmware updating for WIZS2E modules.

5.1 Reading module information

When starting ConfigTool or clicking the  button, WIZS2E ConfigTool will search all WIZS2E modules that have connected in the same LAN. Figure below shows the search result with one module in the network. By selecting the MAC address in the list, you can read and configure all the parameters of this module.

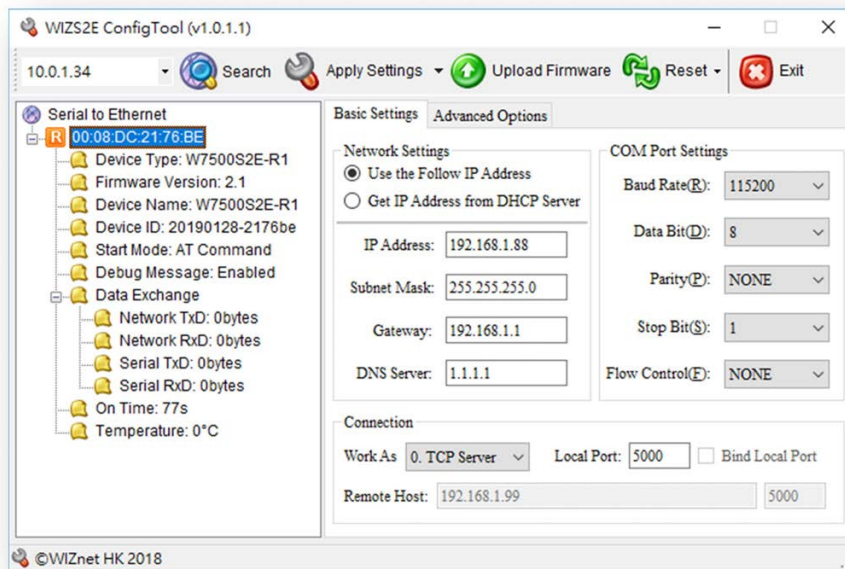

Figure 5-1 WIZS2E ConfigTool “Basic Settings”

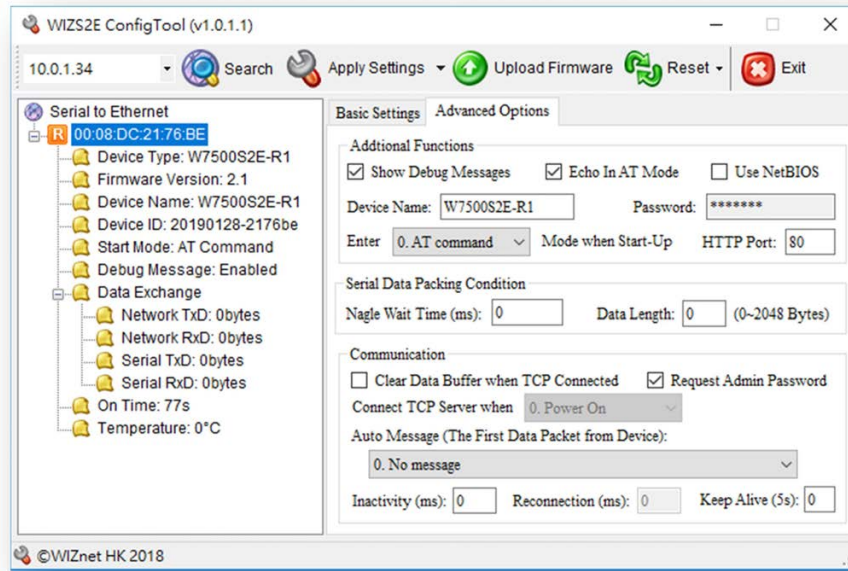
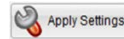

Figure 5-2 WIZS2E ConfigTool “Advance Options”

5.2 Modify the device settings

If there is any updated parameter, please click



button to save your configuration and restart.

5.3 Reset the module

First click the “Reset” button and then to click the “Reset Now!” button to reset the module without saving any setting

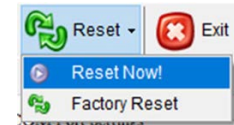

5.4 Useful features

Switching PC network interface

If the PC has more than one network interface, user can select the network interface which connecting to the module. By selecting “Update IP list!” the interface list will be refreshed.



Right-click context menu

WIZS2E ConfigTool provides additional options via the context menu. When right-click on a device in the list on the left side, the function list will appear as shown in the figure below.

1. Expand/collapse all device details
2. The device list can be sorted by MAC address or device type or device name
3. The function "Search again!" is for users to keep the original device list unchanged. Newly searched device would be list under the current device list.

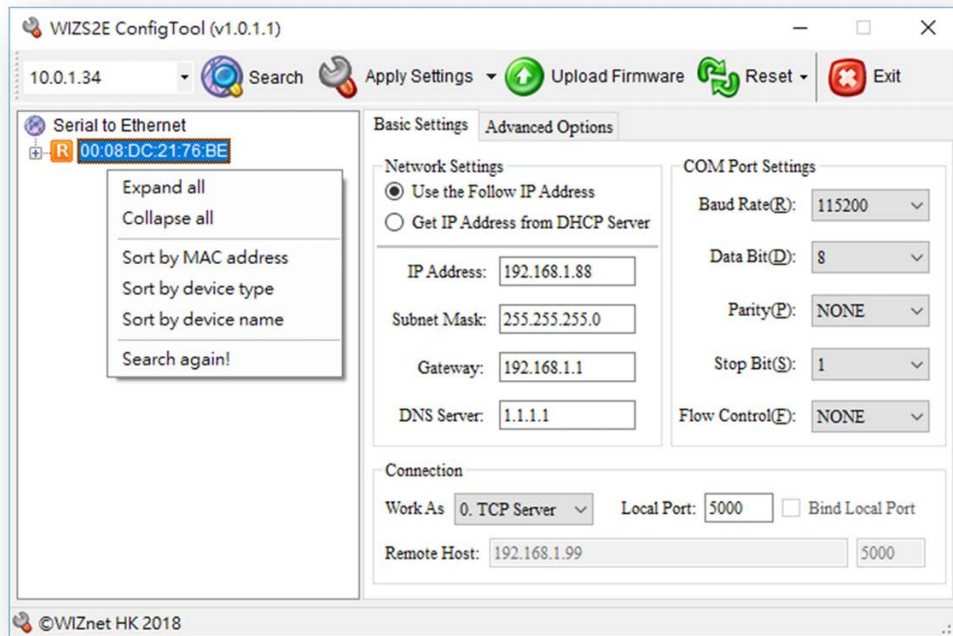

Figure 5-3 Right mouse click menu

6 Introduction of AT command

6.1 AT command overview

AT command can be sent to the serial port of W7500S2E running in AT command mode. AT command is case insensitive. AT command is always starting with string "AT" and ends with "\r\n". Each command has specific response and parameter format.

Below are difference types of AT command:

1. Commands without parameter

Format: AT+<command>\r\n

No extra parameters or symbol after the command.

Example

Command: *AT+EXIT\r\n*

Response: *OK\r\n*.

2. Commands with parameter

Format: AT+<command>=<parameter>\r\n

These commands are for configure certain settings.

Example

Command: *AT+ECHO=1\r\n*

Response: *[ECHO] Value is: 1\r\n OK\r\n*

3. Read commands

Format: AT+<command>?\r\n

These commands read the current settings value.

Example

Command: *AT+ECHO?\r\n*

Response: *[ECHO] Value is: 1\r\n OK\r\n*

Based on different AT command sent, W7500S2E will return with corresponding response. The response type is shown in the table below.

6.2 AT command responds

Table 6-1 AT command responds list

Response type	Response	Description
Error message	Command Invalid\r\nERROR\r\n	Invalid command
	<Error Info>\r\n	Invalid parameter or in the wrong mode
Success message	OK\r\n	Command is executed successfully
	[Command] Value is: <value>\r\nOK\r\n	

6.3 Entering AT command Mode

W7500S2E has two modes, "AT command mode" and "Data pass-through mode". In "AT command mode", W7500S2E is waiting for the AT Command from the serial port. Different settings can be set by serial terminal software or through the serial port of the MCU.

Note: The existing connections will be closed when entering "AT command mode".

When W7500S2E is in "AT command mode" mode, sending "AT\r\n", it will respond with "OK\r\n" if it is working correctly.

In "Data pass-through mode", W7500S2E will not detect any AT command sending to the serial port. All messages received by the serial port will be regarded as data except the special "+++" code below, which switching the module into AT command mode.

Note:

"+++" code rules:

It is needed to send "+" symbol continuously in 3 times through the serial port with 1 second time gap both before and after the "+++".

6.4 AT command list

W7500S2E module serial-to-Ethernet module supports serial AT command for configuration. Also it support sending data through the AT command mode. "AT data transfer command" and "save" command are supported by firmware version 2.2 and above.

6.4.1 AT setting command list

AT setting command is used for configure or read the parameter of W7500S2E. AT command has attribute R: Read, W: Set, R/W: Read and set

Table 6-2 AT command list

Type	Command	Function	Attribute	Max length	Parameters
Control command	AT	Terminal check	R	-	-
	ECHO	Enable or disable echoing	R/W	1	0: Echo off 1: Echo on (default)
	DEBUGMSGEN	Debug message	R/W	1	0: Disable 1: Enable (default)
	NAME	Module name	R/W	15	Must be numbers, alphabets or the combination of both
	PASS	Module password	R/W	15	Must be numbers, alphabets or the combination of both (Default: admin)
	DEFAULT	Reset to factory default	W	15	Module password

	RESET	Save and restart module	W	15	Reset if parameter equals to password
	EXIT	Exit AT command	W	-	-
	SAVE	Save settings	W	-	-
Module settings command	START_MODE	Start mode	R/W	1	0: AT command mode (default) 1: Data pass-through mode
	C1_OP	Operating mode	R/W	1	0: TCP server mode (default) 1: TCP client mode 2: UDP mode
	IP_MODE	IP configuration method	R/W	1	0: Static IP mode (default) 1: DHCP mode
	IP	IP address	R/W	15	Default: 192.168.1.88
	MARK	Subnet mask	R/W	15	Default: 255.255.255.0
	GATEWAY	Gateway	R/W	15	Default: 192.168.1.1
	DNS	DNS server address	R/W	15	Default: 114.114.114.114
	C1_PORT	Local port number	R/W	5	1 ~ 65,535; Default: 5000
	C1_BIND	Local port binding	R/W	1	Valid only in TCP Client mode: 0: Disable (default) 1: Enable
	DNSSEN	DNS for remote host	R/W	1	0: Disable (default) 1: Enable
	C1_CLI_IP1	Remote host IP address	R/W	15	Default: 192.168.1.99
	C1_CLI_PP1	Remote host port number	R/W	5	1 ~ 65,535; Default: 5000
	DOMAIN	Remote host name	R/W	32	Default: www.iwiznet.cn
	RECONTIME	Reconnection interval	R/W	5	Valid only in TCP client mode Value range: 0~60000; Unit: ms Default: 0 (reconnect immediately)
	NETBIOS	NetBIOS	R/W	1	0: Disable (default) 1: Enable
Serial settings command	C1_BAUD	Baud rate index	R/W	2	0: 300 6: 14,400 12: 128,000 1: 600 7: 19,200 13: 230,400 2: 1,200 8: 38,400 14: 256,000 3: 2,400 9: 56,000 15: 460,800 4: 4,800 10: 57,600 5: 9,600 11: 115,200 (default)
	C1_DATAB	Data bit index	R/W	1	0: 7 bit 1: 8 bit (default)
	C1_STOPB	Stop bit	R/W	1	0: 1 bit (default) 1: 2 bit
	C1_PARITY	Parity bit	R/W	1	0: Disable (default) 1: Odd 2: Even
	C1_SER_C	Serial flow control / RS-485 enable output	R/W	1	0: Disable (default) 1: Enable CTS/RTS hardware flow control

					2: Enable 485EN pin
C1_BUF_CLS	Clear Buffer if Connected	R/W	1		Valid only in TCP modes 0: Disable (default) 1: Enable
C1_SER_LEN	Serial data packing length	R/W	4		Value range: 0~2048 byte Default: 0 (Disable)
C1_SER_T	Serial data packing Nagle wait time (ms)	R/W	5		Value range: 0~60000, unit: ms; Default: 0 (Disable)
C1_IT	Inactivity timeout (ms)	R/W	5		Valid only in TCP modes Value range: 0 ~ 60000, unit: ms; Default: 0 (disable this function)
C1_TCPAT	TCP keepalive interval	R/W	3		Valid only in TCP modes Value range: 0~255, unit 5s; Default: 0 (Disable)
C1_LINK_P	TCP password authentication	R/W	1		Valid only in TCP server mode 0: Disable (Default) 1: Enable
C1_LINK_T	Connection Condition	R/W	1		Valid only in TCP client mode 0: Connect when power on (default) 1: Connect when receiving data from serial
C1_LINK_M	Send Hello Message	R/W	1		Valid only in TCP modes 0: Disable (Default) 1: Send module name 2: Send MAC address 3: Send IP address
Management command	C1_SEND_NUM	Serial sent byte	R	-	Range: 0 ~ 4,294,967,295
	C1_RCV_NUM	Serial received byte	R	-	Range: 0 ~ 4,294,967,295
	NETSEND	Network sent byte	R	-	Range: 0 ~ 4,294,967,295
	NETRCV	Network received byte	R	-	Range: 0 ~ 4,294,967,295
	PRE	List of preset values	R	-	-
	RUNTIME	Module uptime	R	-	-
	VER	Firmware version	R	-	-
	MAC	MAC address	R	-	-
	SN	Serial number	R	-	-
	TYPE	Module P/N	R	-	-
	WEB_PORT	Web configuration port number	R/W	5	1 ~ 65,535; Default: 80

6.4.2 AT data transfer command list

“AT data transfer command” is supported by firmware version 2.2 and above.

Table 6-3 AT command list

Type	Command	Function	Attribute	Max length	Parameters
Data transfer command	LINK	PHY link status	R	-	0: PHY link not connect 1: PHY link connected
	LISTEN	Listening on TCP	W	-	-
	CONNECT	Initiate TCP connection	W	-	-
	TCP_STATUS	TCP connection status	R	-	0: TCP closed 1: TCP connected
	UDP	Establish UDP	W	-	-
	SEND	Send the length	W	4	Range: 0 ~ 2048 Default: 0 (any length)
	RCV	Receive the length	W	4	Range: 0 ~ 2048 Default: 0 (any length)
	RLEN	Receive data length	R	-	Remaining length to be received
	DISCON	Close socket	W	-	-
	CLEAR	Clear network receiving buffer	W	-	-

6.5 AT command details

6.5.1 Control command

AT (Terminal check)

Command format	Parameters	Usage
AT	Nil	Read
Response	OK\r\n	
Description	If module is in AT command mode, return is value above	
Example	<i>Command: AT\r\n</i> <i>Response: OK\r\n</i>	

It will check if the module if it is working properly in AT command mode.

ECHO (Enable or disable echoing)

Command format	Parameters	Usage
AT+ECHO?	Nil	Read
AT+ECHO=<parameter>	0: echo off 1: echo on (default)	Set
Response	[ECHO] Value is: <value>\r\nOK\r\n	
Example	<i>Command: AT+ECHO?\r\n</i> <i>Response: [ECHO] Value is:1\r\nOK\r\n</i>	

In AT command mode, echo on means the module could directly respond any input command line to the serial interface. Thus, this option may help users more easily through serial terminal software manually. However, this may increase the difficulty to parse the return output if the serial is connected to an MCU in an embedded system. Turn echo off in this case.

DEBUGMSGEN (Debug message)

Command format	Parameters	Usage
AT+DEBUGMSGEN?	Nil	Read
AT+DEBUGMSGEN=<parameter>	0: Disable 1: Enable (default)	Set
Response	[DEBUGMEGEN] Value is: <value>\r\nOK\r\n	
Example	<i>Command: AT+DEBUGMSGEN=1\r\n</i> <i>Response: [DEBUGMSGEN] Value is:1\r\nOK\r\n</i>	

This will enable debug message sending to the serial interface. Thus, this option may help users more easily through serial terminal software manually.

NAME (Module name)

Command format	Parameters	Usage
AT+NAME?	Nil	Read
AT+NAME=<parameter>	User defined device name. It must be numbers, alphabets or the combination of both. Maximum length is 15 byte. Cannot be null Default: Module P/N	Set
Response	[NAME] Value is: <value>\r\nOK\r\n	
Example	<i>Command: AT+NAME=User1\r\n</i> <i>Response: [NAME] Value is:User1\r\nOK\r\n</i>	

Module name can be user defined to identify the different devices in their application.

Note: When using NetBIOS name function, device name should follow the "AT+NETBIOS" naming rules.

PASS (Module password)

Command format	Parameters	Usage
AT+PASS?	Nil	Read
AT+PASS=<parameter>	User define password. It must be numbers, alphabets or the combination of both. Maximum length is 15 byte. It is case sensitive and cannot be null. Default: admin	Set
Response	[PASS] Value is: <value>\r\nOK\r\n	
Example	<i>Command: AT+PASS=Admin1\r\n</i> <i>Response: [PASS] Value is:Admin1\r\nOK\r\n</i>	

The password is used for factory reset, TCP password authentication, Web page login and the AT command "DEFAULT" and "RESET".

Note:

Factory reset – When factory reset by AT command, correct password must be input. Please refer to the "Default" command for details.

TCP Password authentication – If enable, the exact password need to be sent in the first packet. If password is correct, communication can be started; otherwise connection closed. For details, please refer to the C1_LINK_P command.

DEFAULT (Reset to factory default)

Command format	Parameters	Usage
AT+DEFAULT=<parameter>	Module password; Default: admin	Set
Response	OK\r\n	
Example	<i>Command: AT+DEFAULT=admin\r\n</i> <i>Response: OK\r\n</i>	

- Exact password must be input to execute this command
- When this command is successfully executed, the module restores all settings to factory default and enters to AT command mode.

RESET (Save and restart the module)

Command format	Parameters	Usage
AT+RESET=<parameter>	Module password; Default: admin	Set
Response	OK\r\n	
Example	<i>Command: AT+RESET=admin\r\n</i> <i>Response: OK\r\n</i>	

- Exact password must be input to execute this command
- It will save the current settings
- Restart the module so that the setting is effective
- The module will be in preset "Start mode" after reset.

EXIT (Save and exit command mode)

Command format	Parameters	Usage
AT+EXIT	Nil	Execute
Response	OK\r\n	
Example	<i>Command: AT+EXIT\r\n</i> <i>Response: OK\r\n</i>	

- It will save the current settings
- Restart the module and make the settings take effect
- Module will be entered into "Data pass-through mode"

SAVE (Save settings)

Command format	Parameters	Usage
AT+SAVE	Nil	Execute
Response	OK\r\n	
Example	<i>Command: AT+SAVE\r\n</i> <i>Response: OK\r\n</i>	

- It will save the current settings
- Make the settings take effect
- After execute this command, the module will be still in "AT command mode". This is for save the settings in the AT data transfer mode.

Note: This command is supported by firmware version 2.2 and above.

6.5.2 Module settings command

START_MODE (Start mode)

Command format	Parameters	Usage
AT+START_MODE?	Nil	Read
AT+START_MODE=<parameter>	0: AT command mode (default) 1: Data pass-through mode	Set
Response	[START_MODE] Value is:<value>\r\nOK\r\n	
Example	<i>Command: AT+START_MODE=1\r\n</i> <i>Response: [START_MODE] Value is:1\r\nOK\r\n</i>	

This defines the starting mode after power on or reboot or executing the "RESET" command.

C1_OP (Operating mode)

Command format	Parameters	Usage
AT+C1_OP?	Nil	Read
AT+C1_OP=<parameter>	0: TCP Server (Default) 1: TCP Client 2: UDP	Set
Response	[C1_OP] Value is:<value>\r\nOK\r\n	
Example	<i>Command: AT+C1_OP=1\r\n</i> <i>Response: [C1_OP] Value is:1\r\nOK\r\n</i>	

It defines the operating mode for data transfer. If in AT data transfer mode and using this command to change the operating mode. It is needed to use the command "DISCON" command to close the TCP/UDP communication first.

IP_MODE (IP configuration mode)

Command format	Parameters	Usage
AT+IP_MODE?	Nil	Read
AT+IP_MODE=<parameter>	0: Static IP mode (default) 1: DHCP mode	Set
Response	[IP_MODE] Value is:<value>\r\nOK\r\n	
Example	<i>Command: AT+IP_MODE=1\r\n</i> <i>Response: [IP_MODE] Value is:1\r\nOK\r\n</i>	

In static IP mode, the IP address, gateway, subnet mask and DNS server address are required configure by the user. In DHCP mode, device will get all above IP parameters from the DHCP server.

IP (IP address)

Command format	Parameters	Usage
AT+IP?	Nil	Read
AT+IP=<parameter>	Default: 192.168.1.88	Set
Response	[IP] Value is:<value>\r\nOK\r\n	
Example	<i>Command: AT+IP=192.168.1.88\r\n</i> <i>Response: [IP] Value is:192.168.1.88\r\nOK\r\n</i>	

The IP address has format in human-readable notations for IPv4, such as 172.16.254.1; maximum length of IP address is 15 bytes. This value is effective only if IP configuration mode (IP_MODE) is in "Static IP mode".

MARK (Subnet mask)

Command format	Parameters	Usage
AT+MARK?	Nil	Read
AT+MARK=<parameter>	Default: 255.255.255.0	Set
Response	[MARK] Value is:<value>\r\nOK\r\n	
Example	<i>Command: AT+MARK=255.255.255.0\r\n</i> <i>Response: [MARK] Value is:255.255.255.0\r\nOK\r\n</i>	

The subnet mask format in human-readable notations for IPv4, such as 255.255.255.0; maximum length is 15 bytes. This value is effective only if IP configuration mode (IP_MODE) is in "Static IP mode".

GATEWAY (Gateway)

Command format	Parameters	Usage
AT+GATEWAY?	Nil	Read
AT+GATEWAY=<parameter>	Default: 192.168.1.1	Set
Response	[GATEWAY] Value is:<value>\r\nOK\r\n	
Example	<i>Command: AT+GATEWAY=192.168.1.1\r\n</i> <i>Response: [GATEWAY] Value is:192.168.1.1\r\nOK\r\n</i>	

The gateway IP address has format in human-readable notations for IPv4, such as 172.16.254.1; maximum length of IP address is 15 bytes. This value is effective only if IP configuration mode

(IP_MODE) is in "Static IP mode".

DNS (DNS server address)

Command format	Parameters	Usage
AT+DNS?	Nil	Read
AT+DNS=<parameter>	DNS server address, default: 114.114.114.114	Set
Response	[DNS] Value is: <value>\r\nOK\r\n	
Example	<i>Command: AT+DNS=1.1.1.1\r\n</i> <i>Response: [DNS] Value is: 1.1.1.1\r\nOK\r\n</i>	

DNS server address format is separated into 4 sections; each section is a decimal value and using a dot to separate. The value range for each section is 0-255 therefore the maximum value Dimension for DNS server address is 15 bytes. This command could not accept xxx.xxx.xxx.0 or xxx.xxx.xxx.255 values input.

C1_PORT (Local port number)

Command format	Parameters	Usage
AT+C1_PORT?	Nil	Read
AT+C1_PORT=<parameter>	Local port number, Default: 5000	Set
Response	[C1_PORT] Value is: <value>\r\nOK\r\n	
Example	<i>Command: AT+C1_PORT=5000\r\n</i> <i>Response: [C1_PORT] Value is:5000\r\nOK\r\n</i>	

This command is only valid in TCP server and UDP mode. It defines the port number of the module. The module will use this port number to communicate with other devices. The value range is 0 to 65535.

Note: Please avoid using the same port number for web page configuration, which the port number default is 80)

C1_BIND (Local port binding)

Command format	Parameters	Usage
AT+C1_BIND?	Nil	Read
AT+C1_BIND=<parameter>	0: Disable (Default) 1: Enable	Set
Response	[C1_BIND] Value is: <value>\r\nOK\r\n	
Example	<i>Command: AT+C1_BIND=1\r\n</i> <i>Response: [C1_BIND] Value is:1\r\nOK\r\n</i>	

This command is only valid in TCP client mode, this will enable the blinding to a fixed local port using command "C1_PORT"

DNSSEN (DNS enable)

Command format	Parameters	Usage
AT+DNSSEN?	Nil	Read
AT+DNSSEN=<parameter>	0: Disable (Default) 1: Enable	Set
Response	[DNSSEN] Value is:<value>\r\nOK\r\n	
Example	<i>Command: AT+DNSSEN=1\r\n</i> <i>Response: [DNSSEN] Value is:1\r\nOK\r\n</i>	

This command is only valid in TCP client and UDP modes.

Note:

- If this is enabled and "DOMAIN" is set, "C1_CLI_IP1" command will be invalid. Module will be communicated with the host defined by "Domain".
- If this is disabled and "C1_CLI_IP1" is set, "DOMAIN" command will be invalid. Module will be communicated with the IP defined by "C1_CLI_IP1".

C1_CLI_IP1 (Remote host IP address)

Command format	Parameters	Usage
AT+C1_CLI_IP1?	Nil	Read
AT+C1_CLI_IP1=<parameter>	Default: 192.168.1.99。	Set
Response	[C1_CLI_IP1] Value is:<value>\r\nOK\r\n	
Example	<i>Command: AT+C1_CLI_IP1=192.168.1.99\r\n</i> <i>Response: [C1_CLI_IP1] Value is:192.168.1.99\r\nOK\r\n</i>	

This command is only valid

- In TCP client mode or UDP mode
- "DNSSEN" is enabled

It sets the remote IP address to communicate with W7500S2E.

C1_CLI_PP1 (Remote host port number)

Command format	Parameters	Usage
AT+C1_CLI_PP1?	Nil	Read
AT+C1_CLI_PP1=<parameter>	Range: 1 ~ 65,535, Default: 5000。	Set
Response	[C1_CLI_PP1] Value is:<value>\r\nOK\r\n	
Example	<i>Command: AT+C1_CLI_PP1=5000\r\n</i> <i>Response: [C1_CLI_PP1] Value is:5000\r\nOK\r\n</i>	

This command is valid only in TCP server and UDP mode.

Note: Please prevent to use common port numbers for avoiding conflict with other service on the remote host.

DOMAIN (Remote host name)

Command format	Parameters	Usage
AT+DOMAIN?	Nil	Read
AT+DOMAIN=<parameter>	Remote host domain name default: www.iwiznet.cn Maximum length is 32 bytes	Set
Response	[DOMAIN] Value is: <value>\r\nOK\r\n	
Example	<i>Command: AT+DOMAIN=www.iwiznet.cn\r\n</i> <i>Response: [DOMAIN] Value is:www.iwiznet.cn\r\nOK\r\n</i>	

This command is only valid

- In TCP client mode or UDP mode
- "DNSEN" is enabled

This command sets the remote host server name.

RECONTIME (Reconnection interval)

Command format	Parameters	Usage
AT+RECONTIME?	Nil	Read
AT+RECONTIME=<parameter>	Range: 0~60000 Unit: ms Default: 0 (reconnect immediately)	Set
Response	[RECONTIME] Value is: <value>\r\nOK\r\n	
Example	<i>Command: AT+RECONTIME=1000\r\n</i> <i>Response: [RECONTIME] Value is:1000\r\nOK\r\n</i>	

This command is only valid in TCP client mode & "data pass-through mode".

This command configures the reconnection interval of the TCP client after the module has disconnected from a TCP server. Default value is 0 for reconnecting immediately.

NETBIOS (NetBIOS)

Command format	Parameters	Usage
AT+NETBIOS?	Nil	Read
AT+NETBIOS=<parameter>	0: Disable (Default) 1: Enable	Set
Response	[NETBIOS] Value is: <value>\r\nOK\r\n	
Example	<i>Command: AT+NETBIOS=1\r\n</i> <i>Response: [NETBIOS] Value is:1\r\nOK\r\n</i>	

User can enter the URL [http://\[Module name\]](http://[Module name]) in the browser in the same LAN with the W7500S2E if this command is enable.

6.5.3 Serial settings command

C1_BAUD (Baud Rate)

Command format	Parameters	Usage
AT+C1_BAUD?	Nil	Read
AT+C1_BAUD=<parameter>	0: 300 6: 14,400 12: 128,000 1: 600 7: 19,200 13: 230,400 2: 1,200 8: 38,400 14: 256,000 3: 2,400 9: 56,000 15: 460,800 4: 4,800 10: 57,600 5: 9,600 11: 115,200 (default)	Set
Response	[C1_BAUD] Value is:<value>\r\nOK\r\n	
Example	<i>Command: AT+C1_BAUD=10\r\n</i> <i>Response: [C1_BAUD] Value is:10\r\nOK\r\n</i>	

C1_DATA8 (Data bit)

Command format	Parameters	Usage
AT+C1_DATA8?	Nil	Read
AT+C1_DATA8=<parameter>	0: 7 bit 1: 8 bit (Default)	Set
Response	[C1_DATA8] Value is:<value>\r\nOK\r\n	
Example	<i>Command: AT+DATA8=1\r\n</i> <i>Response: [C1_DATA8] Value is:1\r\nOK\r\n</i>	

C1_STOPB (Stop bit)

Command format	Parameters	Usage
AT+C1_STOPB?	Nil	Read
AT+C1_STOPB=<parameter>	0: 1 bit (Default) 1: 2 bit	Set
Response	[C1_STOPB] Value is:<value>\r\nOK\r\n	
Example	<i>Command: AT+STOPB=1\r\n</i> <i>Response: [C1_STOPB] Value is:1\r\nOK\r\n</i>	

C1_PARITY (Parity bit)

Command format	Parameters	Usage
AT+C1_PARITY?	Nil	Read
AT+C1_PARITY=<parameter>	0: Disable (Default) 1: Odd 2: Even	Set
Response	[C1_PARITY] Value is: <value>\r\nOK\r\n	
Example	<i>Command: AT+C1_PARITY=0\r\n</i> <i>Response: [C1_PARITY] Value is:0\r\nOK\r\n</i>	

C1_SER_C (Serial flow control / RS-485 enable output)

Command format	Parameters	Usage
AT+C1_SER_C?	Nil	Read
AT+C1_SER_C=<parameter>	0: Disable flow control (default) 1: Enable serial CTS/RTS hardware flow control 2: Enable 485EN pin	Set
Response	[C1_SER_C] Value is: <value>\r\nOK\r\n	
Example	<i>Command: AT+C1_SER_C=1\r\n</i> <i>Response: [C1_SER_C] Value is:1\r\nOK\r\n</i>	

This command with parameter equal 1 enables the hardware serial flow control. This may improve the data accuracy for high speed transmission.

Note: This command with parameter equals 2 will enable the 485EN pin. The RTS pin becomes RS-485 enable output for connecting external 485 chips. 485EN pin is supported by firmware version 2.3 and above.

C1_BUF_CLS (Clear Buffer if Connected)

Command format	Parameters	Usage
AT+C1_BUF_CLS?	Nil	Read
AT+C1_BUF_CLS=<parameter>	0: Disable (default) 1: Enable	Set
Response	[C1_BUF_CLS] Value is: <value>\r\nOK\r\n	
Example	<i>Command: AT+C1_BUF_CLS=1\r\n</i> <i>Response: [C1_BUF_CLS] Value is:1\r\nOK\r\n</i>	

This command is valid only in TCP modes & "data pass-through mode".

There may be data in the serial buffer which not being sent out in case of disconnection. Enable this command clears the buffer when establishing TCP connection.

C1_SER_LEN (Serial packaging Length)

Command format	Parameters	Usage
AT+C1_SER_LEN?	Nil	Read
AT+C1_SER_LEN=<parameter>	Value range: 0~2048 byte Default: 0 (Disable data packing)	Set
Response	[C1_SER_LEN] Value is: <value>\r\nOK\r\n	
Example	<i>Command: AT+C1_SER_LEN=10\r\n</i> <i>Response: [C1_SER_LEN] Value is:10\r\nOK\r\n</i>	

This command is valid only in "data pass-through mode".

C1_SER_T (Serial data packing Nagle wait time)

Command format	Parameters	Usage
AT+C1_SER_T?	Nil	Read
AT+C1_SER_T=<parameter>	Value range: 0~60000, unit: ms; Default: 0	Set
Response	[C1_SER_T] Value is: <value>\r\nOK\r\n	
Example	<i>Command: AT+C1_SER_T=1000\r\n</i> <i>Response: [C1_SER_T] Value is:1000\r\nOK\r\n</i>	

This command is valid only in "data pass-through mode".

C1_IT (Inactivity timeout)

Command format	Parameters	Usage
AT+C1_IT?	Nil	Read
AT+C1_IT=<parameter>	Value range: 0 ~ 60000, unit: ms; Default: 0 (disable this function)	Set
Response	[C1_IT] Value is: <value>\r\nOK\r\n	
Example	<i>Command: AT+C1_IT=1000\r\n</i> <i>Response: [C1_IT] Value is:1000\r\nOK\r\n</i>	

This command is valid only in TCP modes & "data pass-through mode".

Define the inactivity timeout period for TCP established sessions in mini seconds (ms).

C1_TCPAT (TCP keepalive interval)

Command format	Parameters	Usage
AT+C1_TCPAT?	Nil	Read
AT+C1_TCPAT=<parameter>	Value range: 0~255, unit 5s; Default: 0 (Disable)	Set
Response	[C1_TCPAT] Value is: <value>\r\nOK\r\n	
Example	<i>Command: AT+C1_TCPAT=1\r\n</i> <i>Response: [C1_TCPAT] Value is:1\r\nOK\r\n</i>	

This command is valid only in TCP modes & "data pass-through mode".

This parameter determines the interval between TCP keep-alive retransmissions until a response is received. Once a response is received, the delay until the next keep-alive transmission is again controlled

by the value.

C1_LINK_P (TCP password authentication)

Command format	Parameters	Usage
AT+C1_LINK_P?	Nil	Read
AT+C1_LINK_P=<parameter>	0: Disable (Default) 1: Enable	Set
Response	[C1_LINK_P] Value is:<value>\r\nOK\r\n	
Example	<i>Command: AT+C1_LINK_P=1\r\n</i> <i>Response: [C1_LINK_P] Value is:1\r\nOK\r\n</i>	

This command is valid only in TCP server mode & "data pass-through mode".

When TCP password authentication is enabled, the module requires password input by the first packet from the Ethernet port. If the password is wrong, it requires re-entering password until it receives a correct password. Module password could be configured or query by the "PASS" command.

C1_LINK_T (Connection Condition)

Command format	Parameters	Usage
AT+C1_LINK_T?	Nil	Read
AT+C1_LINK_T=<parameter>	0: Connect when power on (default) 1: Connect when receiving data from serial	Set
Response	[C1_LINK_T] Value is:<value>\r\nOK\r\n	
Example	<i>Command: AT+C1_LINK_T=1\r\n</i> <i>Response: [C1_LINK_T] Value is:1\r\nOK\r\n</i>	

This command is valid only in TCP client mode & "data pass-through mode".

This is the timing for the module connecting to the TCP server. If it is 0, it will connect when power on. If it is 1, the module will establish the connection establishment when receiving the first package of data from the serial interface. When connection established, the data will be sent to the TCP server and module would be in data pass-through mode.

C1_LINK_M (Send Hello Message)

Command format	Parameters	Usage
AT+C1_LINK_M?	Nil	Read
AT+C1_LINK_M=<parameter>	0: Disable (Default) 1: Send Device ID 2: Send MAC address 3: Send IP address	Set
Response	[C1_LINK_M] Value is:<value>\r\nOK\r\n	
Example	<i>Command: AT+C1_LINK_M=1\r\n</i> <i>Response: [C1_LINK_M] Value is:1\r\nOK\r\n</i>	

This command is valid only in TCP client mode for both "data pass-through mode" & "AT data transfer mode". It will determine the first message to be sent right after connection established.

6.5.4 Management command

C1_SEND_NUM (Serial sent number of byte)

Command format	Parameters	Usage
AT+C1_SEND_NUM?	Nil	Read
Response	[C1_SEND_NUM] Value is:<value>\r\nOK\r\n Display range: 0 ~ 4,294,967,295.	
Example	<i>Command: AT+C1_SEND_NUM? r n</i> <i>Response: [C1_SEND_NUM] Value is:2048 r nOK r n</i>	

This command is valid for both "data pass-through mode" & "AT data transfer mode".

C1_RCV_NUM (Serial received number of byte)

Command format	Parameters	Usage
AT+C1_RCV_NUM?	Nil	Read
Response Description	[C1_RCV_NUM] Value is:<value>\r\nOK\r\n Display range: 0 ~ 4,294,967,295.	
Example	<i>Command: AT+C1_RCV_NUM? r n</i> <i>Response: [C1_RCV_NUM] Value is:2048 r nOK r n</i>	

This command is valid for both "data pass-through mode" & "AT data transfer mode".

NETSEND (Network sent byte)

Command format	Parameters	Usage
AT+NETSEND?	Nil	Read
Response	[NETSEND] Value is:<value>\r\nOK\r\n Display range: 0 ~ 4,294,967,295.	
Example	<i>Command: AT+NETSEND? r n</i> <i>Response: [NETSEND] Value is:2048 r nOK r n</i>	

This command is valid for both "data pass-through mode" & "AT data transfer mode".

NETRCV (Network received byte)

Command format	Parameters	Usage
AT+NETRCV?	Nil	Read
Response Description	[NETRCV] Value is:<value>\r\nOK\r\n Display range: 0 ~ 4,294,967,295.	
Example	<i>Command: AT+NETRCV? r n</i> <i>Response: [NETRCV] Value is:2048 r nOK r n</i>	

This command is valid for both "data pass-through mode" & "AT data transfer mode".

PRE (List of Preset values)

Command format	Parameters	Usage
AT+PRE?	Nil	Read
Response	<pre> DEFAULT: [NAME] :W7500S2E-Z1 [PASS] :admin [DOMAIN] :www.iwiznet.cn [IP] :192.168.1.88 [MARK] :255.255.255.0 [GATEWAY] :192.168.1.1 [DNS] :114.114.114.114 [WEB_PORT] :80 [C1_PORT] :5000 [C1_BAUD] :11[115200] [C1_DATAB] :1[8] [C1_PARITY] :0[NONE] [C1_STOPB] :0[1] [C1_SER_C] :0 [C1_SER_T] :0 [C1_SER_LEN]:0 [C1_CLI_IP1]:192.168.1.99 [C1_CLI_PP1]:5000 CURRENT: [NAME] :W7500S2E-Z1 [PASS] :admin [DOMAIN] :www.iwiznet.cn [IP] :192.168.1.88 [MARK] :255.255.255.0 [GATEWAY] :192.168.1.1 [DNS] :114.114.114.114 [WEB_PORT] :80 [C1_PORT] :5000 [C1_BAUD] :11[115200] [C1_DATAB] :1[8] [C1_PARITY] :0[NONE] [C1_STOPB] :0[1] [C1_SER_C] :0 [C1_SER_T] :0 [C1_SER_LEN]:0 [C1_CLI_IP1]:192.168.1.99 [C1_CLI_PP1]:5000 OK </pre>	

RUNTIME (Module uptime)

Command format	Parameters	Usage
AT+RUNTIME?	Nil	Read
Response	[RUNTIME] Value is:<value>\r\nOK\r\n	
Description	Format: ddd-hh-mm-ss Display range: 000-00-00-00 ~ 999-23-59-59.	
Example	Command: AT+RUNTIME? r n Response: [RUNTIME] Value is:003-15-38-42 r\nOK r n	

VER (Firmware version)

Command format	Parameters	Usage
AT+VER?	Nil	Read
Response	[VER] Value is:<value>\r\nOK\r\n	
Example	Command: AT+VER? r n Response: [VER] Value is:V1.9 r\nOK r n	

MAC (MAC address)

Command format	Parameters	Usage
AT+MAC?	Nil	Read
Response	[MAC] Value is:<value>\r\nOK\r\n	
Example	Command: AT+MAC? r n Response: [MAC] Value is:00.08.DC.11.12.13 r\nOK r n	

SN (Serial Number)

Command format	Parameters	Usage
AT+SN?	Nil	Read
Response	[SN] Value is:<value>\r\nOK\r\n	
Example	Command: AT+SN? r n Response: [SN] Value is:20190102-111213 r\nOK r n	

TYPE (Module part number)

Command format	Parameters	Usage
AT+TYPE?	Nil	Read
Response	[TYPE] Value is: <value>\r\nOK\r\n	
Example	Command: AT+TYPE?\r\n Response: [TYPE] Value is:W7500S2E-Z1\r\nOK\r\n	

WEB_PORT (Web configuration port number)

Command format	Parameters	Usage
AT+WEB_PORT?	Nil	Read
AT+WEB_PORT=<parameter>	Range: 1 ~ 65,535, Default: 80.	Set
Response	[WEB_PORT] Value is: <value>\r\nOK\r\n	
Example	Command: AT+WEB_PORT=80\r\n Response: [WEB_PORT] Value is:80\r\nOK\r\n	

This port number is used for configuration through web browser. The value range is 0 to 65535. If the port wasn't set to 80, the port number should be added to the end of the IP address. For example: http://192.168.1.88:8080 if port is 8080

Note: If the module is in TCP server mode, the web configuration port must be the difference to the local port number (C1_PORT).

6.6 AT Data transfer command

LINK (Detect PHY link status)

Command format	Parameters	Usage
AT+LINK?	Nil	Read
Response	[LINK] Value is: <value>\r\nOK\r\n	
Description	0: no PHY link 1: has PHY link	
Example	Command: AT+LINK?\r\n Response: [LINK] Value is:1\r\nOK\r\n	

Note: This command is supported by firmware version 2.2 and above.

LISTEN (Listening on TCP)

Command format	Parameters	Usage
AT+LISTEN	Nil	Execute
Response	OK\r\n	
Description	Upon successful completion	
Response	<Error Info>\r\n	
Description	Module is not in TCP server mode	
Example	Command: AT+LISTEN\r\n Response: OK\r\n	

This command is valid only in TCP server mode. i.e. "C1_OP" is set as "0". Otherwise, it will respond with error message. It can be closed by the command "DISCON".

Note: After execute this command, TCP connection can be monitor with the "TCP_STATUS" command or the voltage level of the "TCP_STATUS" pin.

This command is supported by firmware version 2.2 and above.

CONNECT (Initiating TCP connection)

Command format	Parameters	Usage
AT+CONNECT	Nil	Execute
Response	OK\r\n	
Description	Upon successful completions	
Response	<Error Info>\r\n	
Description	Module is not in TCP client mode	
Example	<i>Command: AT+CONNECT\r\n</i> <i>Response: OK\r\n</i>	

This command is valid only in TCP client mode. i.e. "C1_OP" is set as "1". Otherwise, it will respond with error message. After execute this command; the module will try to connect to the TCP server. If connection cannot be established in 3s, it returns with error messages.

Note: After execute this command, TCP connection can be monitor with the "TCP_STATUS" command or the voltage level of the "TCP_STATUS" pin. This command is supported by firmware version 2.2 and above.

TCP_STATUS (TCP connection status)

Command format	Parameters	Usage
AT+TCP_STATUS	Nil	Read
Response	[TCP_STATUS] Value is:<value>\r\n OK\r\n	
Description	0: TCP not connected 1: TCP connected	
Example	<i>Command: AT+TCP_STATUS?\r\n</i> <i>[TCP_STATUS] Value is:1\r\n OK\r\n</i>	

This command is valid only in TCP modes.

This command and the "TCP_STATUS" pin can both be used to monitor the TCP connection status.

Note: This command is supported by firmware version 2.2 and above.

UDP (Establish UDP connection)

Command format	Parameters	Usage
AT+UDP	Nil	Execute
Response	OK\r\n	
Description	Upon successful completions	
Response	<Error Info>\r\n	
Description	Module is not in TCP client mode	
Example	<i>Command: AT+UDP\r\n</i> <i>Response: OK\r\n</i>	

This command is valid only in UDP mode i.e. "C1_OP" is set as "2". Otherwise, it will return with error.

Note: This command is supported by firmware version 2.2 and above.

SEND (Send byte of data)

Command format	Parameters	Usage
AT+SEND=<parameter>	Range: 0~2048 (bytes), Default: 0 (any length)	Set
Response Description	[SEND] Value is: <value>\r\nOK\r\n Set the length of data to be sent	
Example	<i>Assume module is in TCP mode and TCP connection is connected</i> Command: AT+TCP_STATUS?\r\n [TCP_STATUS] Value is:1\r\n OK\r\n Command: AT+SEND=5\r\n Response: [SEND] Value is:5\r\nOK\r\n Then send data via serial: 12345 Response: 5	
Example	<i>Assume module is in TCP mode and TCP connection is not connected</i> Command: AT+TCP_STATUS?\r\n [TCP_STATUS] Value is:0\r\n OK\r\n Command: AT+SEND=5\r\n Response: [SEND] Value is:5\r\nOK\r\n Then send data via serial: 12345 Response: 0	

- ① If the module is in TCP modes, it is need to check the TCP connection status before using this command. Reference to "TCP_STATUS" for details.
- ② If this command execute successfully, the serial port will get the response value. The next input send to the serial port will be regarded as data and send out. Then, the module will be gone back to AT command mode.
- ③ If the set value is zero, input from the serial port will be packaged by 50ms frame interval. After the first byte sent from the serial port, the data will be sent whenever there is idle time longer than 50ms. Any extra data after 2,048byte will be discarded.
- ④ If the set value is non-zero, the module will wait for receiving data with length of the set value. Any extra data will be discarded.
- ⑤ If data sent successfully, the module will respond with the sent data length.

Note: This command is supported by firmware version 2.2 and above.

RLEN (Receive buffer data Length)

Command format	Parameters	Usage
AT+RLEN?	Nil	Read
Response Description	[RLEN] Value is: <value>\r\nOK\r\n Range: 0 ~ 2048.	
Example	<i>Data in buffer to be received: abcdef</i> Command: AT+RLEN?\r\n Response: [RLEN] Value is:6\r\nOK\r\n	

This command reads the data in the network receiving buffer (with length in bytes).

Note: This command is supported by firmware version 2.2 and above.

RCV (Receive data)

Command format	Parameters	Usage
AT+RCV=<parameter>	Range: 0 ~ 2048, Default: 0 (Whatever length)。	Set and execute
Response	[RCV] Value is:<value>\r\nOK\r\n	
Example	<i>Length of data in buffer to be received: abcdef</i> <i>Command: AT+RCV=0\r\n</i> <i>Response: [RCV] Value is:0\r\nOK\r\n</i> <i>Response: abcdef</i>	

- ① If module is in TCP modes, Receiving rules: If the module is in TCP modes, it is need to check the TCP connection status before using this command. Reference to "TCP_STATUS" for details.
- ② If this command executed successfully, the serial port will send out the data from the network receiving buffer. Then, the module will be gone back to AT command mode.
- ③ If the data in the network buffer has length equal to 2,048bytes, module will not receive further data.
- ④ If the data in the network buffer is less than the received length here, data will not be received and it should respond value 0.

Note: This command is supported by firmware version 2.2 and above.

CLEAR (Clear the network receiving buffer)

Command format	Parameters	Usage
AT+CLEAR	Nil	Execute
Response	OK\r\n	
Example	<i>Command: AT+CLEAR\r\n</i> <i>Response: OK\r\n</i>	

This command clears the data in the network receiving buffer.

Note: This command is supported by firmware version 2.2 and above.

DISCON (Disconnect)

Command format	Parameters	Usage
AT+DISCON	Nil	Execute
Response	OK\r\n	
Example	<i>Command: AT+DISCON\r\n</i> <i>Response: OK\r\n</i>	

This command closes the socket opened in TCP server, TCP client and UDP modes.

Note: This command is supported by firmware version 2.2 and above.

6.7 AT command script examples

6.7.1 TCP server mode script example

```
AT\r\n                                     //Terminal check
OK\r\n
AT+DEBUGMSGEN=0\r\n                       //Disable debug message
[DEBUGMSGEN] Value is:0\r\nOK\r\n
AT+ECHO=0\r\n                               //Echo on
[ECHO] Value is:0\r\nOK\r\n
AT+START_MODE=1\r\n                       //Configure start mode into "Data pass-through mode"
[START_MODE] Value is:1\r\nOK\r\n
AT+C1_OP=0\r\n                               //Configure into TCP server mode
[C1_OP] Value is:0\r\nOK\r\n
AT+IP_MODE=0\r\n                           //Set into static IP mode
[IP_MODE] Value is:0\r\nOK\r\n
AT+IP=192.168.1.88\r\n                       //Set local IP address
[IP] Value is:192.168.1.88\r\nOK\r\n
AT+C1_PORT=5000\r\n                         //Set the local port number
[C1_PORT] Value is:5000\r\nOK\r\n
AT+RESET=admin\r\n                          //Save the setting, restart in enter data pass-through mode
OK\r\n
```

6.7.2 TCP client AT command mode script example

```

AT|r|n                                     //Terminal check
OK|r|n
AT+DEBUGMSGEN=0|r|n                       //Turn off the serial debugging message
[DEBUGMSGEN] Value is:0|r|nOK|r|n
AT+ECHO=0|r|n                              //Echo off
[ECHO] Value is:0|r|nOK|r|n
AT+START_MODE=0|r|n                       //Configure start mode to "AT command mode"
[START_MODE] Value is:0|r|nOK|r|n
AT+C1_OP=1|r|n                             //Configure as TCP client mode
[C1_OP] Value is:1|r|nOK|r|n
AT+IP_MODE=1|r|n                          //Configure the module to DHCP mode
[IP_MODE] Value is:1|r|nOK|r|n
AT+DNSEN=0|r|n                             //Disable DNS function
[DNSEN] Value is:0|r|nOK|r|n
AT+C1_CLI_IP1=192.168.1.99|r|n            //Configure remote TCP server IP address
[C1_CLI_IP1] Value is:192.168.1.99|r|nOK|r|n
AT+C1_CLI_PP1=5000|r|n                   //Configure remote TCP server port number
[C1_CLI_PP1] Value is:5000|r|nOK|r|n
AT+SAVE\r|n                               //Save configuration and restart
OK|r|n
AT+CONNECT|r|n                            //Initiate a connection request to the remote TCP server
OK|r|n
AT+TCP_STATUS?|r|n                       //Read the TCP connection status
[TCP_STATUS] Value is:1|r|nOK|r|n
AT+SEND=5|r|n                             //Notification module will send 5 bytes of data
OK|r|n
Serial sends data:12345
Serial receives:5
TCP server sends data: abcdef
AT+RLEN?|r|n                              //Read data length in the receiving buffer.
[RLEN] Value is:6|r|nOK|r|n
AT+RCV=3|r|n                              //Receive 3 bytes of data
[RCV] Value is:3|r|nOK|r|n
abc
AT+CLEAR|r|n                              //Clear network receiving buffer
OK|r|n
AT+DISCON|r|n                             //Close TCP connection
OK|r|n

```

7 Web configuration

You log into your WIZS2E's firmware through a browser. It is recommended using Chrome.

7.1 Login page

At the address field of the browser, type the IP address of your module. The default IP address of WIZS2E module is 192.168.1.88. You may first search for your module IP by the ConfigTool software. Figure below shows the login page.

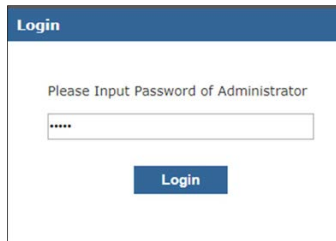
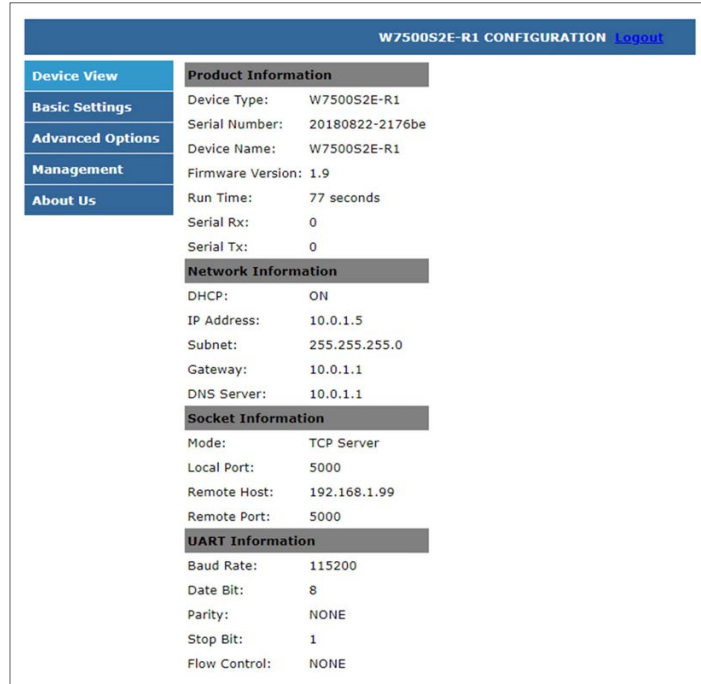

Figure 7-1 Login page

The default password is "admin".

This page shows the basic information of the W7500S2E module.



W7500S2E-R1 CONFIGURATION Logout	
Device View	Product Information
Basic Settings	Device Type: W7500S2E-R1
Advanced Options	Serial Number: 20180822-2176be
Management	Device Name: W7500S2E-R1
About Us	Firmware Version: 1.9
	Run Time: 77 seconds
	Serial Rx: 0
	Serial Tx: 0
	Network Information
	DHCP: ON
	IP Address: 10.0.1.5
	Subnet: 255.255.255.0
	Gateway: 10.0.1.1
	DNS Server: 10.0.1.1
	Socket Information
	Mode: TCP Server
	Local Port: 5000
	Remote Host: 192.168.1.99
	Remote Port: 5000
	UART Information
	Baud Rate: 115200
	Data Bit: 8
	Parity: NONE
	Stop Bit: 1
	Flow Control: NONE

Figure 7-2 Device View page

7.2 Basic Settings

Figure below shows W7500S2E basic settings page. It separates into four sections. On each screen, you may need to click "Save Settings" before you move onto the next screen. After you've done that, you may click "Reset" to reset the module for the settings to be applied.

Please know that the session time for the W7500S2E webserver is 5 minutes. After 5 minutes of inactivity, re-login is required.

Figure 7-3 Basic Settings page

Network Setting

Setting	Description	Default
MAC Address:	MAC address of the module	Not configurable
Use DHCP:	DHCP mode option	Disable (uncheck)
IP address:	IP address of the module	192.168.1.88
Subnet Mask:	Subnet Mask	255.255.255.0
Gateway:	Gateway	192.168.1.1
DNS Server:	DNS server IP address	114.114.114.114

Socket Setting

Setting	Description	Default
Start mode:	"AT Command Mode" or "Data pass-through mode"	"AT Command Mode"
Socket Type:	"TCP Server", "TCP Client" or "UDP mode"	"TCP Server"

Remote Host:	Remote host IP address or domain name	192.168.1.99
Remote Port:	Remote host port number	5000
Local Port:	Local port number (0~65535; avoid used port)	5000
Bind Local Port:	Only valid in TCP client mode	Disable (unchecked)

UART Setting

Setting	Description	Default
Baud Rate:	1200bps ~ 1,152,000bps	115,200
Data Bit:	7 or 8 bits	8
Parity:	NONE, ODD or EVEN	NONE
Stop Bit:	1 or 2 bits	1
Flow Control:	NONE or "CTS/RTS mode"	NONE

Save Settings: Click to save all these settings

Reset: Click to Restart (Need to click "Save Settings" to apply the setting)

7.3 Advance Options

Figure below shows the advance settings page of WIZS2E module.

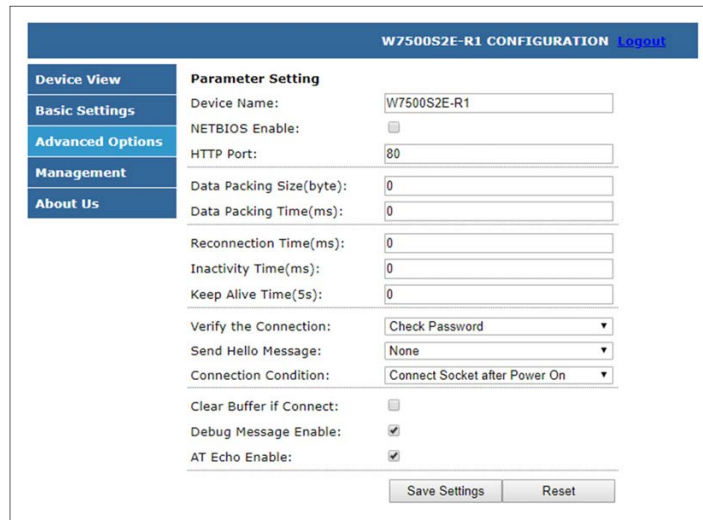

The screenshot shows the 'W7500S2E-R1 CONFIGURATION' page with a 'Logout' link. A left sidebar contains navigation tabs: 'Device View', 'Basic Settings', 'Advanced Options' (selected), 'Management', and 'About Us'. The main content area is titled 'Parameter Setting' and includes the following fields:

- Device Name: W7500S2E-R1
- NETBIOS Enable:
- HTTP Port: 80
- Data Packing Size(byte): 0
- Data Packing Time(ms): 0
- Reconnection Time(ms): 0
- Inactivity Time(ms): 0
- Keep Alive Time(5s): 0
- Verify the Connection: Check Password
- Send Hello Message: None
- Connection Condition: Connect Socket after Power On
- Clear Buffer if Connect:
- Debug Message Enable:
- AT Echo Enable:

At the bottom of the form are 'Save Settings' and 'Reset' buttons.

Figure 7-4 Advance Options page

Device Name: The module name, the user could make its own definition, it could be any characters. Maximum 15 bytes

NETBIOS Enable: NetBIOS option, checked the NetBIOS to activate this feature, default: disable; if activated, the user could type the device name (case insensitive) in the browser to login to the webserver of this module.

HTTP Port: W7500S2E's web server port number, default: 80; value range is 0 to 65535.

If the port wasn't set to 80, then need to input the port at the end of the IP address. For example: 192.168.1.88: 8000.

Note: If W7500S2E works in TCP server mode, HTTP port must not be set to the same as the local port of the module.

Data Packing Size (byte): Data packaging length, default: 0 (disable), maximum size is 2048 bytes.

Data Packing Time (ms): Waiting interval of data packet, default: 0 (disable), maximum value is 60,000.

Reconnection Time (ms): reconnection interval, only effective in TCP client mode, default: 0 (instant reconnection), value range: 0 to 60000, unit: ms

Inactivity Time (ms): Set the Inactivity timeout, only effective in TCP modes, value range: 0 ~ 60000, unit: ms, default: 0 (disable)

Keep Alive Time (5s): Set the Keep alive timer, only effective in TCP modes, value range: 0 ~ 65536, unit: 5s; default: 0 (disable)

Verify the Connection: When the user created a communication in TCP and this command was enabled, the module requires a password confirmation from the Ethernet side. If the password is wrong, it requires re-entering password until it receives a correct password. Default: No (disable)

Send Hello Message: Define message sent when TCP connection succeeds. Selections includes: "None", "Send Device Name", "Send MAC Address" or "Send IP Address". Default: "None" (disable)

Connection Condition: In TCP client mode, the connection starts from W7500S2E. This function can set as "Connect socket after power up" (default) or "Connect socket after UART received data"

Clear Buffer if Connect: Data may be left in the serial buffer in case of disconnection. Enable this command clears the buffer when establishing TCP connection. Default: uncheck (disable)

Debug Message Enable: This will enable debug message sending to the serial interface. Thus, this option may help users more easily through serial terminal software manually. Default: checked (enable)

AT Echo Enable: Echo means WIZS2E module could directly return the input values to the serial interface. Thus, this option may help some users working more easily through serial terminal software. However, this may cause trouble if the serial is connected to an embedded system. Turning off this function may help. Default: checked (enable)

7.4 Management

Clicking "Management" to get into device management page as figure below, this page contains 2 sections: Password Settings and Management

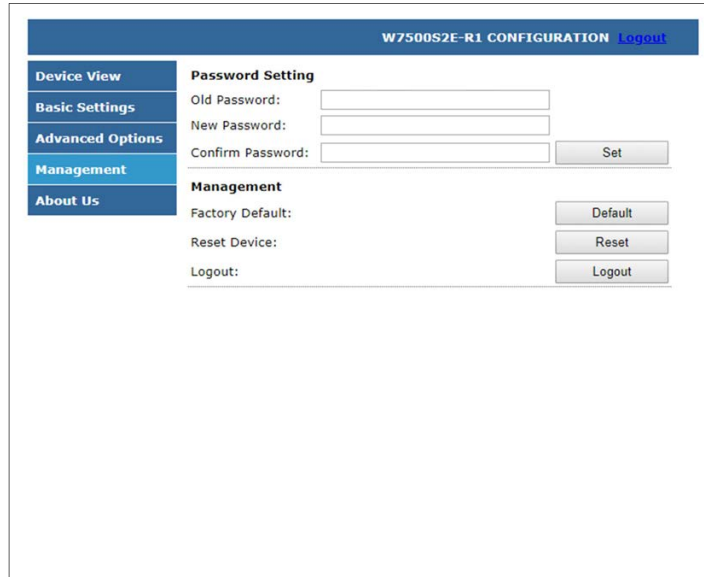

Figure 7-5 Management page

Password Setting

- Old Password - the old password, default: admin
- New Password - Enter new password. Maximum for 15 bytes. It must be numbers, alphabets or the combination of both. It does not accept blank as input value.
- Confirm Password - Re-enter the new password
- Set - Submit button for renewing password

Management

- Factory Default - factory reset button, pressing this button will activate factory reset procedure. It shows a prompt window for re-confirmation is procedure, please click "OK" for factory reset procedure and back to login page.
- Reset Device - Reset the module
- Logout – Logout back to the login page

8 Factory reset

If you forget the password of the module, the user could reset all setting of the module back to factory default. There are three kinds of method to factory reset:

8.1 By ConfigTool

In the WIZS2E ConfigTool, first select the module which you need to factory reset.

Please click "Reset" button and then click "Factory Reset" button to factory reset the module back to default settings.

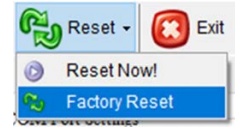

8.2 By using AT command

For details of AT command (default) to factory reset, please refer to the command "DEFAULT" in section 6.5.1.

8.3 By hardware

Factory reset through evaluation board

Press the DEFAULT button for more than 3 seconds for factory reset.

Factory reset through module pin



Figure 8-1 through the module default PIN to restore factory settings

W7500S2E has a factory reset PIN. Pull down the DEFAULT pin for over 3 seconds to activate factory reset when the module is power on.

9 Firmware upgrade

Please make sure the IP address of the module needs to be in the same subnet with the host computer. Then perform the steps below:

- Click "Search"
- Click the designated module
- Click "Upload Firmware" button
- Choose the related firmware bin file

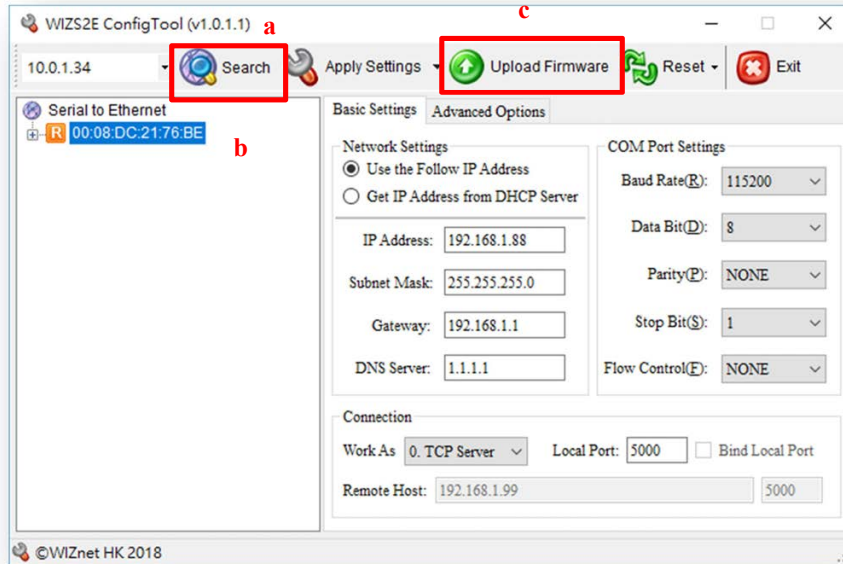

Figure 9-1 WIZS2E firmware upgrade through ConfigTool

Disclaimers

WIZNET H.K. LIMITED and its subsidiaries (“WIZnet”) reserve the right to make changes, corrections, enhancements, modifications, and improvements to WIZnet products and/or to this document at any time without notice. Purchasers should obtain the latest relevant information on WIZnet products before placing orders. WIZnet products are sold pursuant to WIZnet’s terms and conditions of sale in place at the time of order acknowledgement. Purchasers are solely responsible for the choice, selection, and use of WIZnet products and WIZnet assumes no liability for application assistance or the design of Purchasers’ products. No license, express or implied, to any intellectual property right is granted by WIZnet herein. Resale of WIZnet products with provisions different from the information set forth herein shall void any warranty granted by WIZnet for such product. WIZnet and the WIZnet logo are trademarks of WIZnet. All other products or service names are the property of their respective owners. Information in this document supersedes and replaces information previously supplied in any prior versions of this document.

Copyright © WIZnet H.K. Ltd. All rights reserved.