



WAP321015-PCSC2

Dual Wavelength SMD Type Emitter

Features

- Side view 1204 package
- Viewing Angle = $\pm 65^\circ$
- Compatible with infrared and vapor phase reflow solder process
- High reliability
- RoHS compliance

Applications

- Optical indicator.
- Switch and Symbol Display.

Description

The WAP321015-PCSC2 is a double LED housed in a miniature SMD package. The device has a White and Amber LED.

Static electricity and surge damage the LEDs.

It is recommended to use a wrist band or anti-electrostatic glove when handling the LEDs.

Package Outline

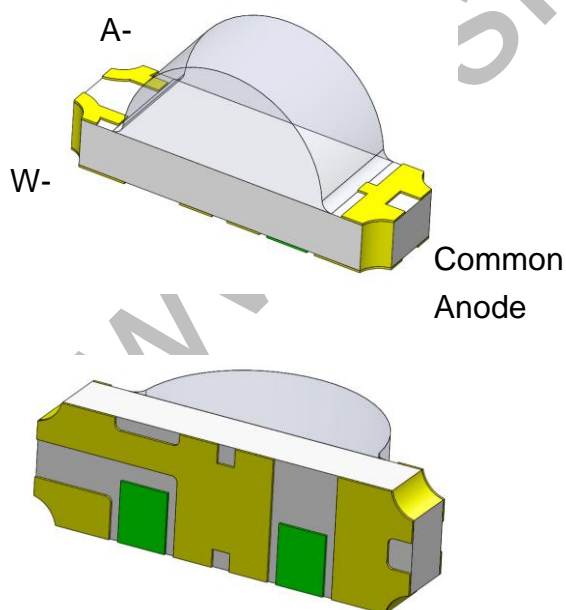

Schematic

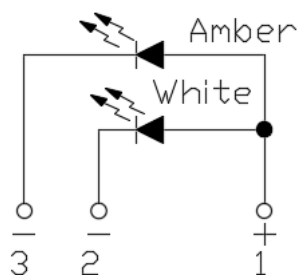

**Absolute Maximum Rating at 25°C**

Symbol	Parameters		Ratings	Units	Notes
I _F	Continuous Forward Current	W	25	mA	
		A	25		
I _{FP}	Peak Forward Current	W	60	mA	1
		A	60		
V _R	Reverse Voltage		5	V	
T _{opr}	Operating Temperature		-40 ~ +85	°C	
T _{stg}	Storage Temperature		-40 ~ +100	°C	
T _{sol}	Soldering Temperature		260	°C	2
P _D	Power Dissipation at(or below) 25°C Free Air Temperature	W	95	mW	
		A	60		

Electro-Optical Characteristics *TA = 25°C (unless otherwise specified)***Optical Characteristics (White)**

Symbol	Parameters	Test Conditions	Min	Typ	Max	Units	Notes
I _V	Luminous Intensity	I _F =5mA	112	-	285	mcd	3
λ _D	Dominant Wavelength	I _F =5mA	-	-	-	nm	4
θ _{1/2}	Angle of Half Intensity	I _F =5mA	-	±65	-	deg	

Electrical Characteristics

Symbol	Parameters	Test Conditions	Min	Typ	Max	Units	Notes
V _F	Forward Voltage	I _F =5mA	2.6	-	3.2	V	
I _R	Reverse Current	V _R =5V	-	-	1	μA	

Optical Characteristics (Amber)

Symbol	Parameters	Test Conditions	Min	Typ	Max	Units	Notes
I _V	Luminous Intensity	I _F =5mA	18	-	45	mcd	3
λ _D	Dominant Wavelength	I _F =5mA	600	-	610	nm	4
θ _{1/2}	Angle of Half Intensity	I _F =5mA	-	±65	-	deg	



Electrical Characteristics

Symbol	Parameters	Test Conditions	Min	Typ	Max	Units	Notes
V _F	Forward Voltage	I _F =5mA	1.6	-	2.2	V	
I _R	Reverse Current	V _R =5V	-	-	1	μA	

Notes:

- 1. I_{FP} Conditions--Pulse Width ≤ 100μs and Duty ≤ 10%.
- 2. Soldering time ≤ 10 seconds.
- 3. Bin Range of Luminous Intensity

White				
Bin Code	Min	Max	Unit	Condition
R	112	180	mcd	I _F =5mA
S	180	285		
Amber				
Bin Code	Min	Max	Unit	Condition
M	18.0	28.5	mcd	I _F =5mA
N	28.5	45.0		

Tolerance of: Luminous Intensity ±10%



4. Bin Range of Chromaticity Coordinates

Bin Code	CIE_x	CIE_y	Bin Code	CIE_x	CIE_y
A	0.2650	0.2760	B	0.2570	0.2760
	0.2717	0.2880		0.2703	0.3000
	0.2877	0.2880		0.2953	0.3000
	0.2810	0.2760		0.2820	0.2760
C	0.2703	0.3000	D	0.2836	0.3240
	0.2836	0.3240		0.2969	0.3480
	0.3086	0.3240		0.3219	0.3480
	0.2953	0.3000		0.3086	0.3240
E	0.2916	0.3240			
	0.2982	0.3360			
	0.3141	0.3360			
	0.3075	0.3240			

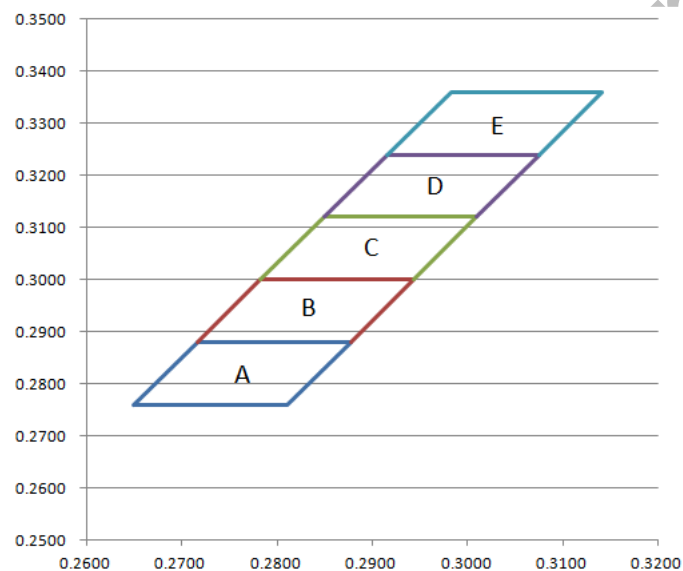

Tolerance of Dominant Wavelength: ± 1 nm.



Typical Characteristic Curves

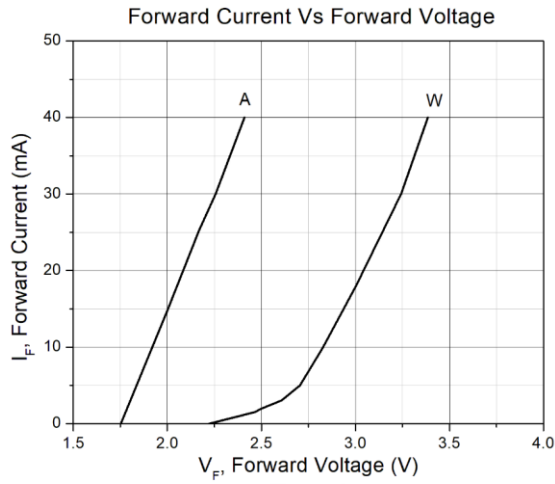

Figure 1

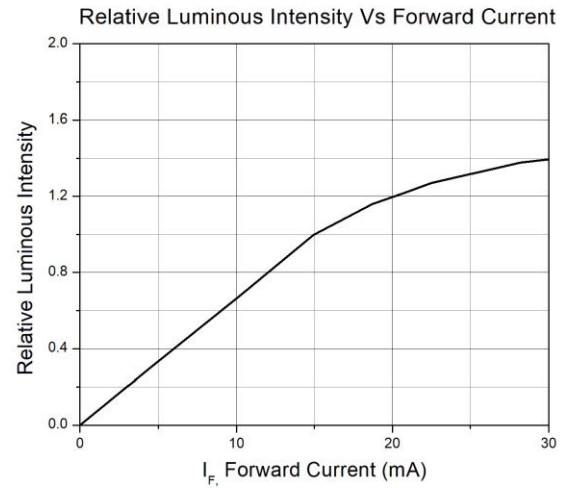

Figure 2

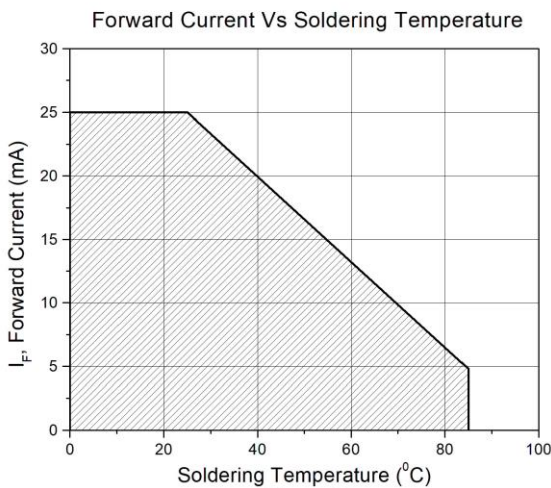

Figure 3

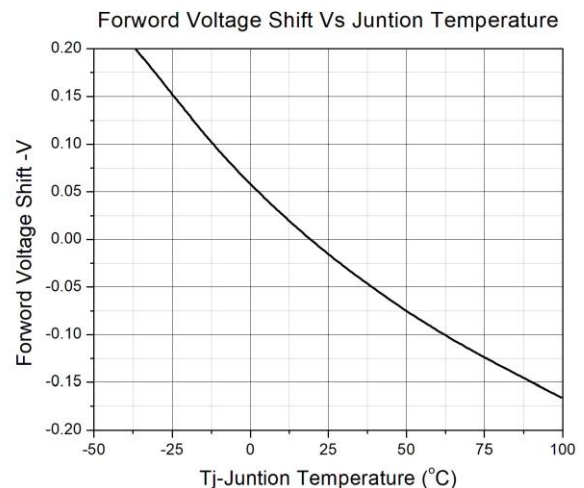

Figure 4

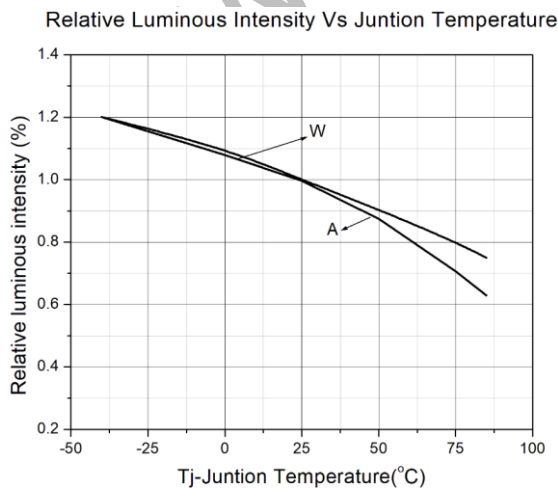

Figure 5

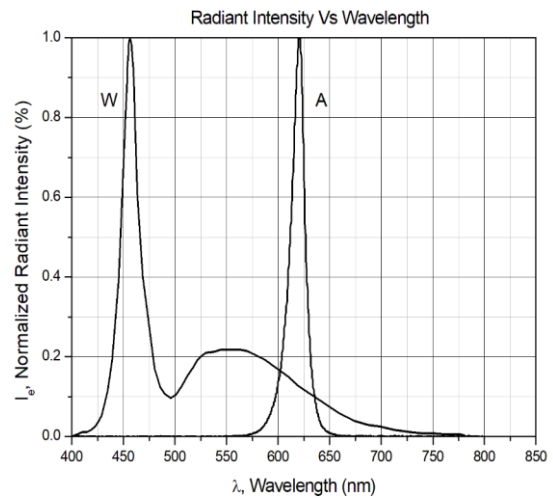
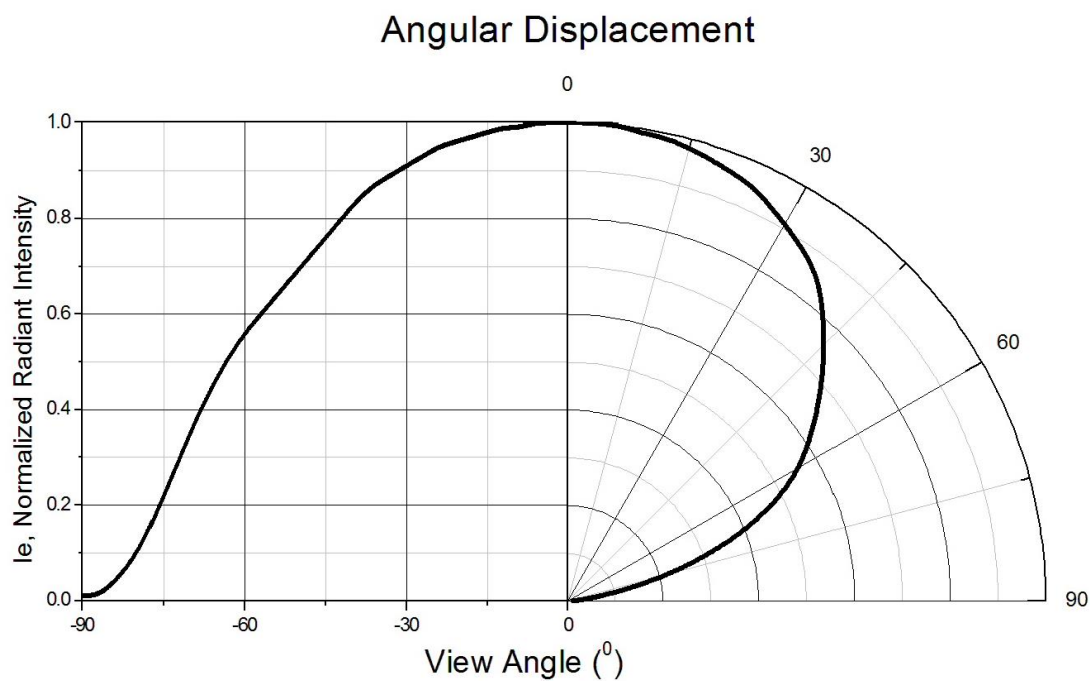

Figure 6



Typical Characteristic Curves



View Angle (°)
Figure 7

WWW.SIG



Package Dimension *All dimensions are in mm, unless otherwise stated*

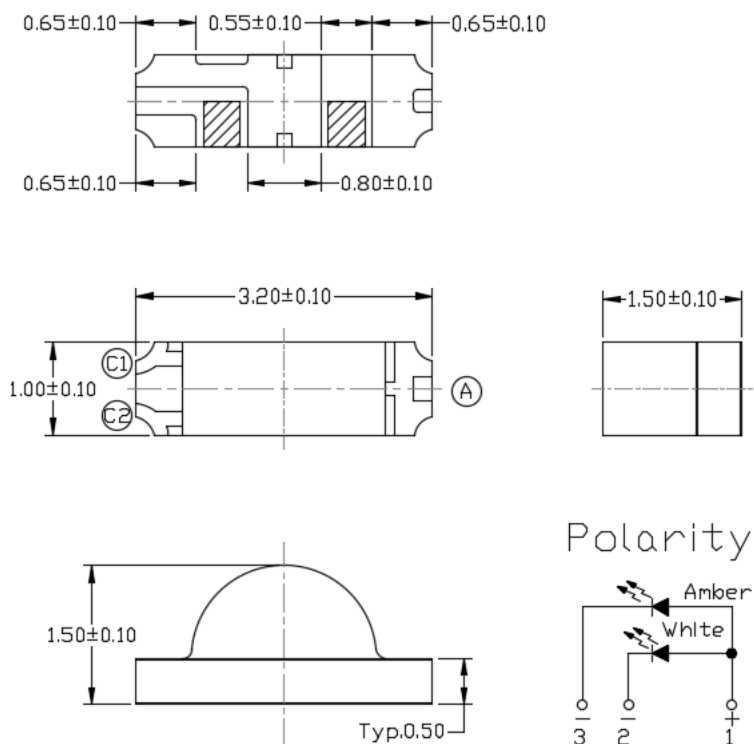

Note: Tolerance unless mentioned is ± 0.1 mm.

Recommended Soldering Mask *All dimensions are in mm, unless otherwise stated*

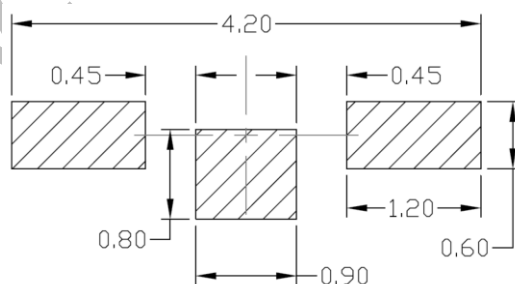

Note: Tolerance unless mentioned is ± 0.1 mm.

Ordering Information

Part Number	Description	Quantity
WAP321015-PCSC2	Tape & Reel	2000 pcs



Reel Dimension *All dimensions are in mm, unless otherwise stated*

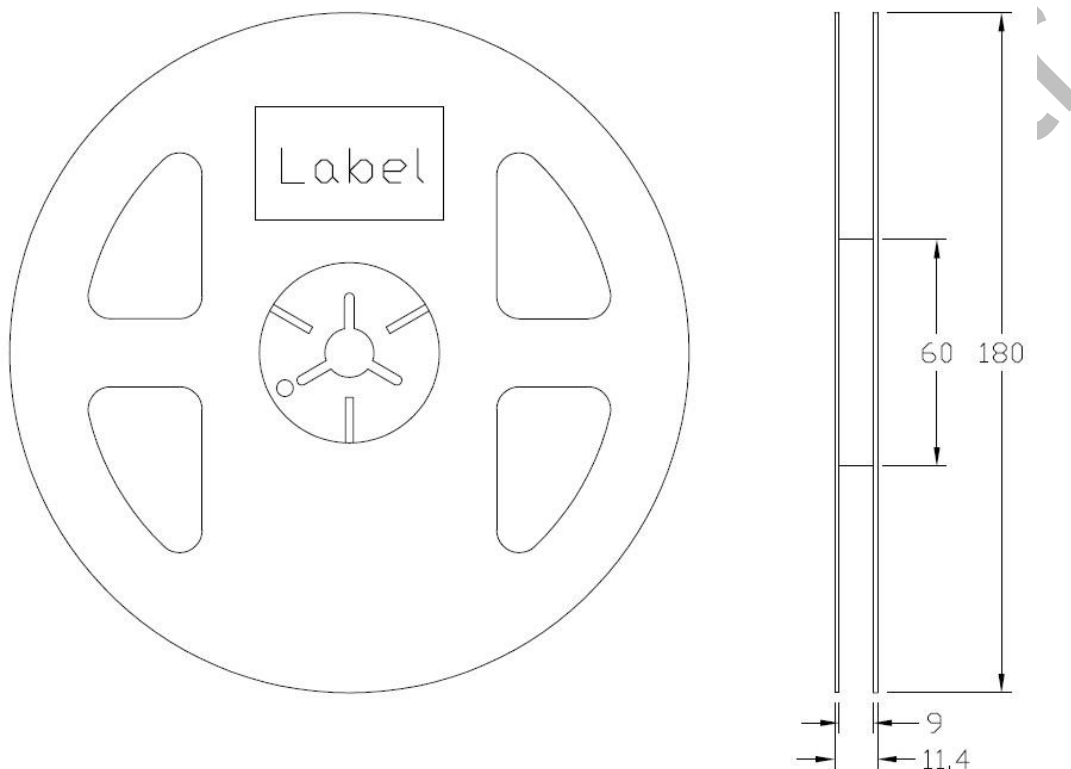

Tape Dimension *All dimensions are in mm, unless otherwise stated*

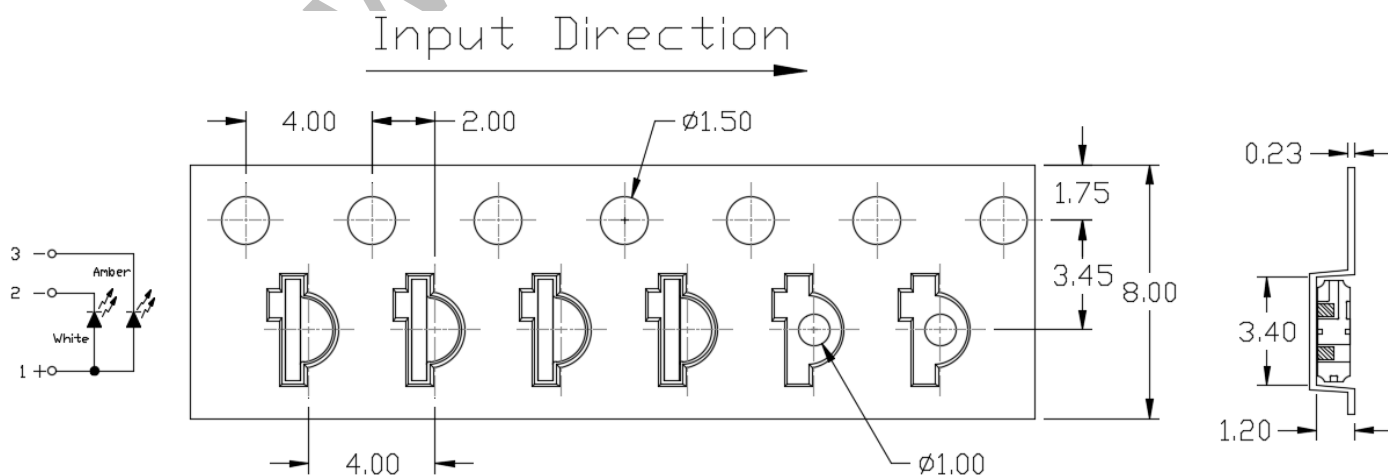

Note: Tolerance unless mentioned is ± 0.1 mm.



Label Form Specification

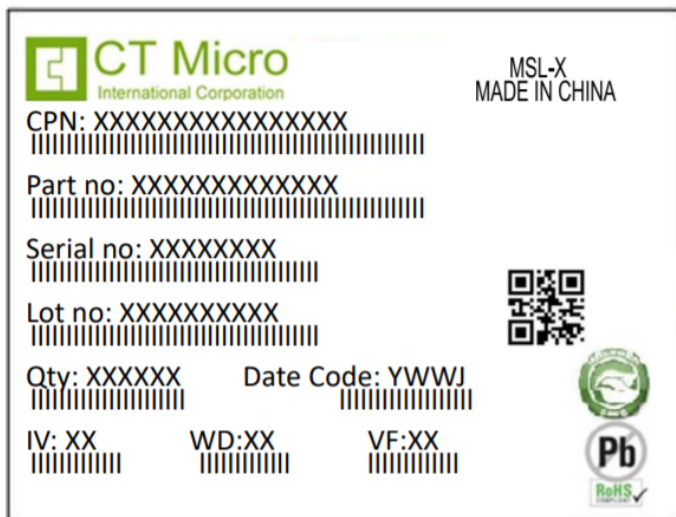

CPN : Customer Part Number
 Part no: CTM Production Number
 Serial no: Production Number
 Lot no: Lot number
 Q'ty: Packing Quantity
 Date Code: Manufacture Date
 IV : Bin Code of Luminous Intensity
 WD : Bin Code of Dominant Wavelength
 VF : Bin Code of Forward Voltage
 MADE IN CHINA: Production Place

Storage Condition

1. Do not open moisture proof bag before the products are ready to use.
2. The moisture barrier bag should be stored at 30°C and 90%R.H. max. before opening.
Shelf life of non-opened bag is 12 months after the bag sealing date.
3. After opening the moisture barrier bag floor life is 1 year at 30°C/60%RH. max. Unused LEDs should be resealed into moisture barrier bag. (Refer to J-STD-020 Standard)
4. If the moisture absorbent material has faded away or the LEDs have exceeded the storage time, baking treatment should be performed using the J-STD-033 Standard conditions.



Reflow Profile

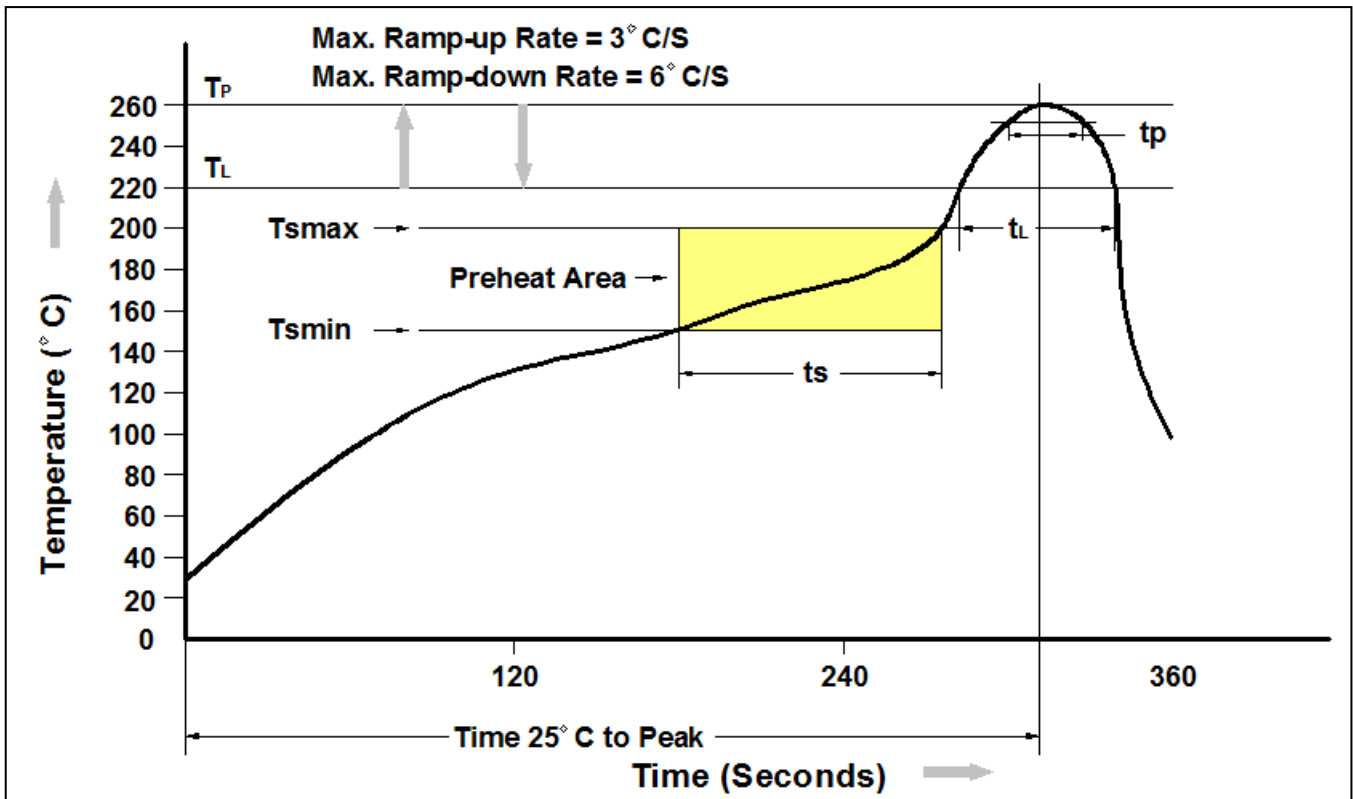

Profile Feature	Pb-Free Assembly Profile
Temperature Min. (T _{min})	150°C
Temperature Max. (T _{max})	200°C
Time (t _s) from (T _{min} to T _{max})	60-120 seconds
Ramp-up Rate (t _L to t _P)	3°C/second max.
Liquidous Temperature (T _L)	217°C
Time (t _L) Maintained Above (T _L)	60 – 150 seconds
Peak Body Package Temperature	260°C +0°C / -5°C
Time (t _P) within 5°C of 260°C	30 seconds
Ramp-down Rate (T _P to T _L)	6°C/second max
Time 25°C to Peak Temperature	8 minutes max.



DISCLAIMER

CT MICRO RESERVES THE RIGHT TO MAKE CHANGES WITHOUT FURTHER NOTICE TO ANY PRODUCTS HEREIN TO IMPROVE RELIABILITY, FUNCTION OR DESIGN. CT MICRO DOES NOT ASSUME ANY LIABILITY ARISING OUT OF THE APPLICATION OR USE OF ANY PRODUCT OR CIRCUIT DESCRIBED HEREIN; NEITHER DOES IT CONVEY ANY LICENSE UNDER ITS PATENT RIGHTS, NOR THE RIGHTS OF OTHERS.

CT MICRO ARE NOT AUTHORIZED FOR USE AS CRITICAL COMPONENTS IN LIFE SUPPORT DEVICES OR SYSTEMS WITHOUT EXPRESS WRITTEN APPROVAL OF CT MICRO INTERNATIONAL CORPORATION.

- 1. Life support devices or systems are devices or systems which, (a) are intended for surgical implant into the body, or (b) support or sustain life, or (c) whose failure to perform when properly used in accordance with instruction for use provided in the labelling, can be reasonably expected to result in significant injury to the user.*
- 2. A critical component is any component of a life support device or system whose failure to perform can be reasonably expected to cause the failure of the life support device or system, or to affect its safety or effectiveness.*